

COBHAM

EXPLORER 710

User manual



Document number: 98-140012-E

Release date: 15 July 2015

Disclaimer

Any responsibility or liability for loss or damage in connection with the use of this product and the accompanying documentation is disclaimed by Thrane & Thrane A/S. The information in this manual is provided for information purposes only, is subject to change without notice and may contain errors or inaccuracies. Manuals issued by Thrane & Thrane A/S are periodically revised and updated. Anyone relying on this information should acquire the most current version e.g. from www.cobham.com/communications-and-connectivity/satcom, **Service and support**, or from the distributor. Thrane & Thrane A/S is not responsible for the content or accuracy of any translations or reproductions, in whole or in part, of this manual from any other source. In the event of any discrepancies, the English version shall be the governing text.

Thrane & Thrane A/S is trading as Cobham SATCOM.

Copyright

© 2015 Thrane & Thrane A/S. All rights reserved.

Trademark acknowledgements

- **Inmarsat** is a registered trademark of the International Maritime Satellite Organisation (IMSO) and is licensed by IMSO to Inmarsat Limited and Inmarsat Ventures plc.
- Other product and company names mentioned in this manual may be trademarks or trade names of their respective owners.

Safety summary

The following general safety precautions must be observed during all phases of operation, service and repair of this equipment. Failure to comply with these precautions or with specific warnings elsewhere in this manual violates safety standards of design, manufacture and intended use of the equipment. Cobham SATCOM assumes no liability for the customer's failure to comply with these requirements.

Do not operate in an explosive atmosphere

Do not operate the equipment in the presence of flammable gases or fumes. Operation of any electrical equipment in such an environment constitutes a definite safety hazard.

Keep away from live circuits

Operating personnel must not remove equipment covers. Component replacement and internal adjustment must be made by qualified maintenance personnel. Do not replace components with the power cable connected. Under certain conditions, dangerous voltages may exist even with the power cable removed. To avoid injuries, always disconnect power and discharge circuits before touching them.

Do not service alone

Do not attempt internal service or adjustments unless another person, capable of rendering first aid resuscitation, is present.

Do not substitute parts or modify equipment

Because of the danger of introducing additional hazards, do not substitute parts or perform any unauthorized modification to the equipment.

Keep away from antenna front

This device emits radio frequency energy when switched on. To avoid injury, keep a minimum safety distance of 1 m from the antenna front when the EXPLORER 710 is on.

For information on the safety distance from the transceiver (WLAN), see the [FCC/IC Radiation Exposure statement](#) on the next page.



Garder à l'écart de l'avant de l'antenne

Le présent appareil émet des radiofréquences lors de son utilisation. Afin d'éviter tout risque pour la santé, une distance minimale de 1 m est nécessaire entre l'utilisateur et l'avant de l'EXPLORER 710.

Pour plus d'informations à propos de la distance de sécurité avec l'appareil (WLAN), veuillez consulter [Déclaration de l'IC sur l'exposition aux radiations](#) sur la page suivante.

Only use approved batteries from Cobham SATCOM

Use of non approved batteries may result in explosion, fire, electrical shock or injury.

Observe marked areas

Under extreme heat conditions do not touch areas of the EXPLORER 710 that are marked with this symbol, as it may result in injury.

The terminal has been designed for full usability meaning that there are no restrictions to which interfaces can be used simultaneously. This means that you can use all the interfaces at once at any temperature



within -25 to 55 °C. Be aware that the terminal will get very hot when it is operated at 55 °C with all interfaces active and it is therefore marked with a heating label.

FCC/IC Radiation Exposure statement

WLAN: Transceiver Unit (when separated from the Antenna Unit):

This equipment complies with FCC and IC radiation exposure limits for an uncontrolled environment. This equipment should be installed and operated at a distance greater than 20 centimeters (8 inches) between the transceiver unit and yourself or any bystander to comply with the Radiation Exposure Requirements.

Déclaration de l'IC sur l'exposition aux radiations

WLAN: L'émetteur-récepteur (quand séparé de l'antenne) :

Le présent appareil est conforme aux limites de l'IC sur l'exposition aux rayonnements établies pour un environnement non-contrôlé. Le présent appareil doit être installé et utilisé à une distance minimum de 20 centimètres (8 pouces) entre l'émetteur-récepteur et l'utilisateur ou tout autre individu pour être conforme à la réglementation en matière d'exposition radiologique.

Safety note from battery supplier

Korean text:

전지

경고 : 발열, 화재, 폭발등의 위험을 수반할 수 있으니 다음 사항을 지켜주시기 바랍니다 .

- 화기에 가까이 하지 말 것
- 분해, 압착, 관통 등의 행위를 하지 말 것
- 높은 곳에서 떨어뜨리는 등 비정상적 충격을 주지 말 것
- 전지 단자에 목걸이, 동전, 열쇠, 시계 등 금속 제품이 닿지 않도록 주의할 것 (휴대컴퓨터용 전지가 아닌 경우 생략 가능)
- 60°C 이상의 고온에 노출하지 말 것

휴대 기기 , 제조업체가 보증한 리튬 2 차전지 사용할 것

English translation:

Battery

Warning: Hazards such as high temperature, fire or explosion can happen. To avoid such hazards, observe the following directions and recommendations.

- Keep away from fire.
- Do not disassemble, break or penetrate the battery.
- Do not drop the battery.
- Do not touch the terminals of the battery with conductive materials such as coins, keys, watches etc.
- Do not expose the battery to temperatures above 60 °C.
- Only use Li-Ion batteries that are approved by the manufacturer.

Antenna safety instructions

Use only manufacturer supplied antennas.
Antenna minimum safe distance: 1 m

Antenna gain

Directional, with maximum gain of 14.6 dB with reference to isotropic.

The Federal Communications Commission has adopted a safety standard for human exposure to RF (Radio Frequency) energy which is below the OSHA (Occupational Safety and Health Act) limits.

Antenna mounting

The antenna supplied by the manufacturer must be located such that during radio transmission, no person or persons can come closer than the above indicated minimum safe distance to the front face of the antenna, i.e. 1 m.

L'antenne fournie par le fabricant doit être placée de telle sorte que, durant les transmissions radio, personne ni aucun groupe de personnes ne puisse s'approcher à une distance inférieure à la distance de sécurité minimal indiquée ci-dessus, c.-à-d., 1 m.

To comply with current FCC RF Exposure limits, the antenna must be installed at or exceeding the minimum safe distance shown above, and in accordance with the requirements of the antenna manufacturer or supplier.

Antenna substitution

Do not use any other antenna than the models supplied or recommended by the manufacturer. You may be exposing people to excess radio frequency radiation. You may contact the manufacturer for further instructions.

Radiation warning



WARNING! Maintain a separation distance of at least 1 m from the front face of the antenna to a person.

You, as the qualified end-user of this radio device, must control the exposure conditions of bystanders to ensure the minimum separation distance (above) is maintained between the antenna and nearby persons, for satisfying RF Exposure compliance. The operation of this transmitter must satisfy the requirements of General Population/ Uncontrolled Environment. Only use the terminal when persons are at least the minimum distance from the front face of the antenna.

About this manual

Intended readers

This manual is a user manual for the EXPLORER 710. The manual is intended for anyone who is using or intends to use the EXPLORER 710. No specific skills are required to operate the EXPLORER 710. However, it is important that you observe all safety requirements listed in the **Safety summary** in the beginning of this manual, and operate the EXPLORER 710 according to the guidelines in this manual.

Related documents

The following documents are related to this manual and to the EXPLORER 710 system.

Title and description	Document number
EXPLORER 710 Getting Started, English	98-139653
EXPLORER 710 Getting Started, Deutsch (German)	98-140216
EXPLORER 710 Getting Started, Français (French)	98-140217
EXPLORER 710 Getting Started, Español (Spanish)	98-140218
EXPLORER 710 Getting Started, Русский (Russian)	98-140219
EXPLORER 710 Getting Started, 中文 (Chinese)	98-140220
EXPLORER 710 Getting Started, 日本語 (Japanese)	98-140221

Typography

In this manual, typography is used as indicated below:

Bold is used for the following purposes:

- To emphasize words.
Example: “Do **not** touch the antenna front during pointing”.
- To indicate what the user should select in the user interface.
Example: “Select **Control panel** > **LAN** and click **Enable**”.

Italic is used to emphasize the paragraph title in cross-references.

Example: “For further information, see *Connecting Cables* on page...”.

Table of Contents

Chapter 1 Introduction to EXPLORER 710	
General description	1
Features and interfaces of the EXPLORER 710	2
Your EXPLORER 710 terminal	4
Chapter 2 To get started	
To unpack and assemble the EXPLORER 710	8
Cable connections	13
To start up the EXPLORER 710	15
To access the network	16
To connect to the WLAN interface	19
To connect to the LAN interface	20
To connect your phone to the EXPLORER 710	21
To make the first call or data session	25
Fixed antenna installation	28
Chapter 3 To use the EXPLORER 710	
BGAN or cellular network	29
User interfaces	29
Data connection with computer, smartphone or tablet	31
Phone connection	38
To charge your smartphone or tablet	40
To see alerts	41
Terminal settings in display	41
To see properties of the EXPLORER 710 in the display	42
Tracking	42
Chapter 4 To use the web interface	
The EXPLORER Connect app	44
The web interface	44
To enter the SIM PIN in the web interface	47

To point the antenna (BGAN)	48
To control data connections from web interface (BGAN)	49
Status information	51
The Control panel	51
To use the logs	52
Battery status information	53
To set up the interfaces	54
To manage connected devices (Traffic control)	58
To manage IP handsets or smartphones	61
Support features	62
Terminal settings	65
To set up your data connection packages (BGAN)	71
Multiple data connections	73
To set up tracking	78
Advanced settings	80
Optional: To set up cellular network for data	94
Chapter 5 Maintenance and troubleshooting	
To get support	96
Software update	97
Maintenance	99
Troubleshooting	102
Log files	113
App. A Technical specifications	
General specifications	114
Battery specifications	115
Interfaces specifications	116
Detachable BGAN antenna specifications	121
Satellite coverage	122

App. B	Conformity	
	General	123
	CE (R&TTE)	123
	IC	123
	FCC	124
Glossary	126
Index	130

Introduction to EXPLORER 710

General description

The EXPLORER 710 is a handy portable terminal supporting simultaneous voice and data communication over BGAN. It provides versatility and high speed access with multiple interfaces for countless applications. Just connect your phone, laptop, smartphone or tablet, point the antenna towards the BGAN satellite - and you are online.



The EXPLORER 710 provides access to the highest bandwidth available on the BGAN network. With BGAN HDR (High Data Rate) you get a portfolio of four channel streaming rates including symmetric and asymmetric options so you only pay for the data you need. The system offers multi-user as well as single-user functionality, making it a flexible solution for a variety of applications, such as:

- Broadcasting
- Internet browsing
- E-mail
- Phone services
- Large file transfers
- Video conference and Streaming
- VPN (Virtual Private Network) access to corporate servers

The EXPLORER 710 can withstand severe environmental conditions such as humidity, dust, extreme weather and changing temperatures. It is small in size and fits easily into a backpack or similar. With the detachable antenna it is well suited for temporary camps or fixed installations.

Features and interfaces of the EXPLORER 710

Features

- Full duplex, single or multi-user, standard data up to 492 kbps
- Support for streaming data at 32, 64, 128, 176, 256 kbps, HDR (asymmetric or symmetric) and BGAN X-Stream
- Standard LAN w. PoE, WLAN, ISDN and Phone ports and USB Host interface
- Detachable antenna with integrated transceiver stand and transceiver-to-antenna range up to 100 m/328 ft.
- Support for **EXPLORER Cellular Modem** for connection to cellular network
- Built-in DHCP/NAT wireless router
- Solar panel direct interface
- Support for battery hot swap
- 10-32 VDC input
- 100-240 VAC power adapter
- Support for GPS, GLONASS and BeiDou navigation systems
- Built-in web interface allowing you to manage your calls and customize the terminal to your specific needs, using a smartphone, computer or tablet.
- Support for the **EXPLORER Connect** smartphone app allowing you to use your phone as a satellite phone and to access the settings of the terminal.
- Advanced network management
- Point-to-Point Protocol over Ethernet (PPPoE)
- Built-in PBX and SIP server managing voice communication
- Remote management and remote access
- Multilingual user interface (English, French, German, Russian, Spanish, Chinese, Japanese)
- CE, FCC, GMPCS and IC certified

Overview of interfaces

The EXPLORER 710 provides a number of interfaces for connection of various types of computers, phones and other equipment.

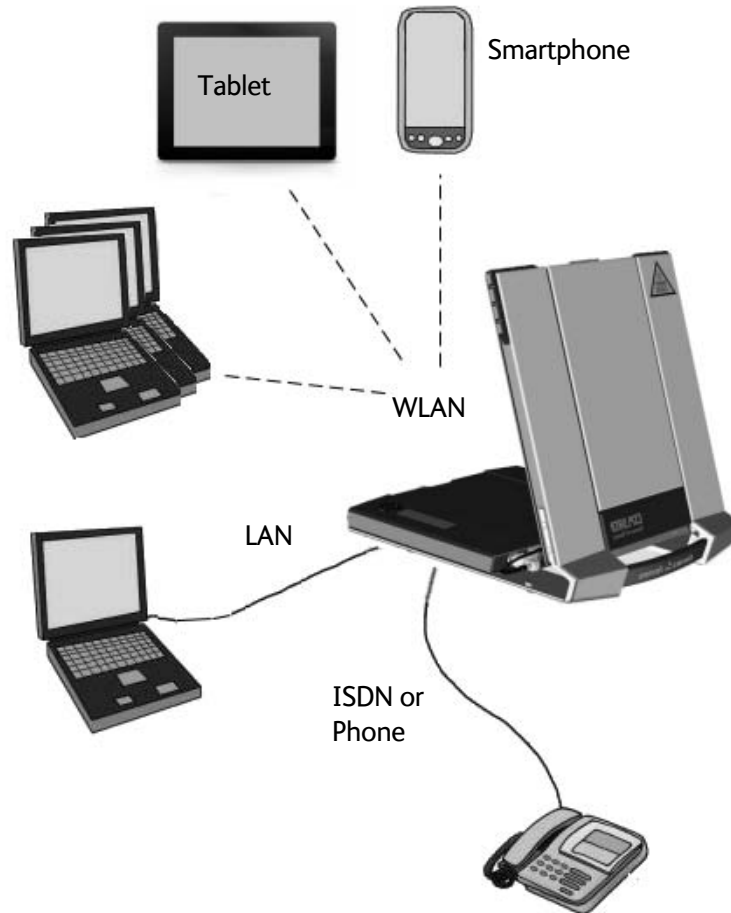

[To get started](#) on page 8 describes how to use each of the available interfaces.

To minimize power consumption

The EXPLORER 710 is designed for minimum power consumption. This means that functions that are not currently used will automatically go into a “sleep mode” to minimize the power consumption. In addition to this automatic sleep mode function, you can disable each of the interfaces if they are not currently used. Note, however, that you will not be able to use these interfaces until you enable them again. For information on how to enable/disable interfaces, see [To enable or disable an interface](#) on page 30.

Your EXPLORER 710 terminal

Overview

The EXPLORER 710 is a compact unit comprising a transceiver with a detachable antenna, compass, display and keypad, all in one unit.



Display and keypad

The EXPLORER 710 has a display and keypad providing quick access to important functions and simple setup, and for displaying status.

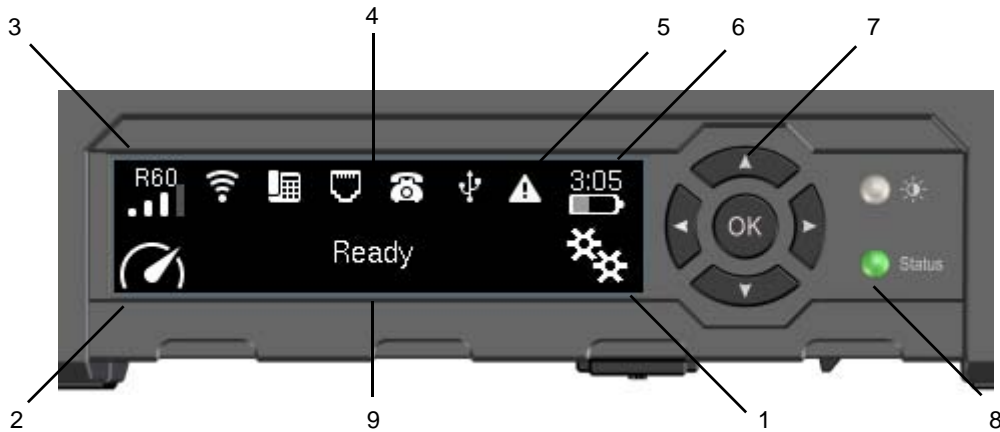

1. Menu: Opens the display menu. For a menu overview, see next page.
2. Connect: Allows you to start a data connection. When a connection package is started, a "1" is added to the icon.
3. Signal strength: Shows the signal strength of the satellite connection and whether the connection is global beam (G), regional beam (R) or narrow beam (N). Press **OK** to see the GNSS position.
4. Interfaces on/off: Allows you to switch the interfaces on or off. Disabled interfaces are crossed out. The WLAN icon shows the number of WLAN-connected devices, if any.
5. Warning: Shows if there are alerts. Press **OK** to see the alerts.
6. Battery status: Shows remaining time for the internal battery and the external battery (if connected).
7. Keypad for navigation: Allows you to move between the available options (arrow keys) and select them (OK).
8. Status indicator: Shows status of the EXPLORER 710. For information on functions, see [Status indicator](#) on page 108.
9. Status text: Shows the current status of the EXPLORER 710 and the network connection. For example, the text may show the status during start-up (see [The registration procedure \(BGAN\)](#) on page 18).

To navigate the display functions

- To **highlight** one of the icons, use the **arrow buttons**.
- To **move around** between the icons, use the **arrow buttons**.
- To **select** menu items, functions or values, press the **OK** key.

Display menu

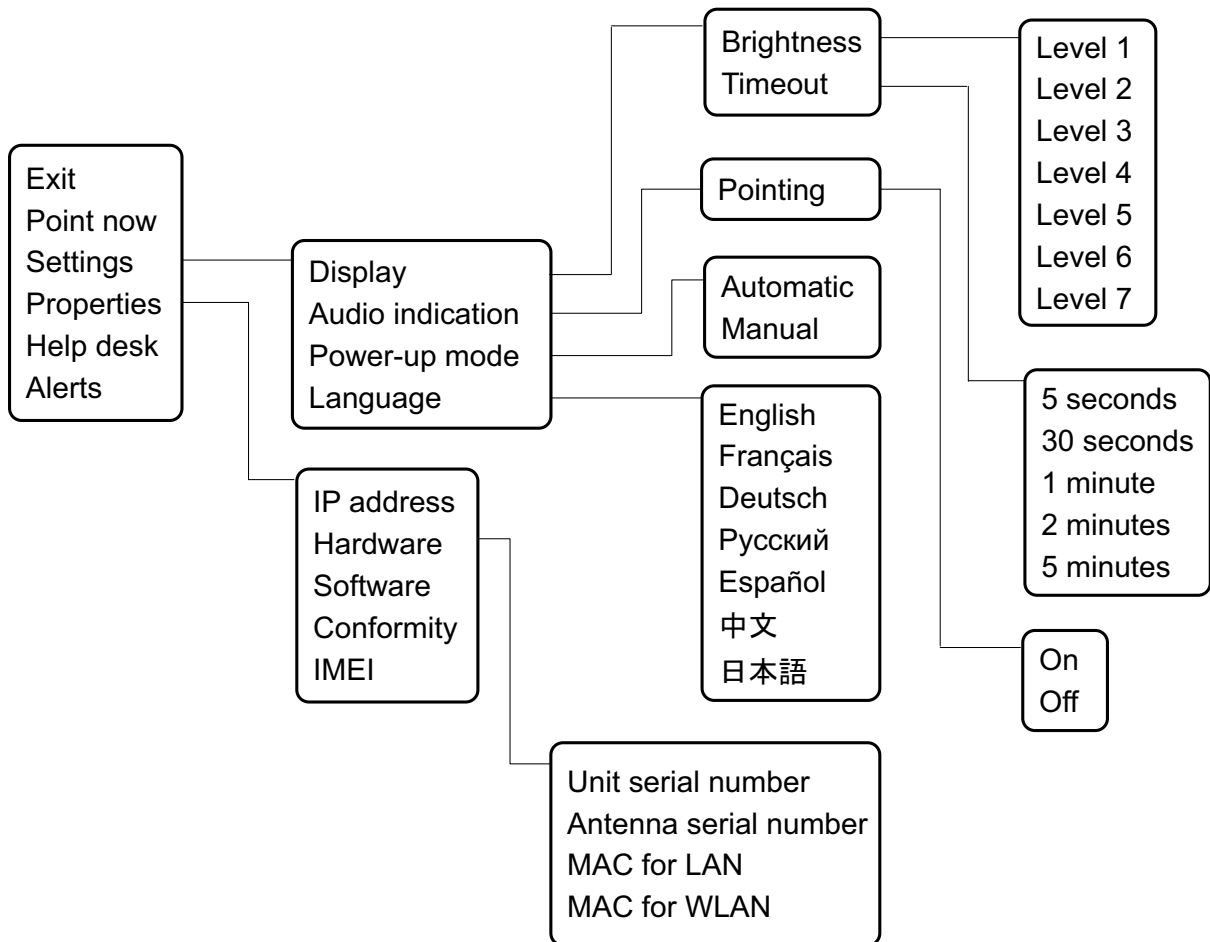

User interfaces

The **keypad and display** described in the previous section are used for pointing the antenna, starting and stopping data sessions, enabling or disabling interfaces and for displaying status and changing simple parameters. To obtain full access to all features and for ease-of-use, you should use a computer or smartphone and the web interface.

The **web interface** is a built-in web interface for easy configuration and daily use. The web interface is accessed from a computer, smartphone or tablet connected to the EXPLORER 710, using an Internet browser. No installation of software is needed. For further information on the web interface, see [To use the web interface](#) on page 43.

A **smartphone app, EXPLORER Connect**, is also available. The app includes a satellite phone function that enables you to make calls to and from your smartphone over the satellite network using the EXPLORER 710 terminal. It also includes the complete feature set from the built-in web interface of the terminal, allowing you to set up and use the terminal with your smartphone. See [The EXPLORER Connect app for smartphones](#) on page 9.

With **AT commands** you can configure and control the EXPLORER 710 from a computer using a Telnet session. For details see [To access the terminal using AT commands](#) on page 36.

Antenna

The white part of the EXPLORER 710, including the support bracket, is the detachable antenna module. The antenna module comprises a GNSS (Global Navigation Satellite System) antenna and a BGAN antenna.

A Wireless LAN antenna is located on the transceiver unit.

Compass

The EXPLORER 710 also provides a compass to help positioning the antenna. For further information on how to use the compass, see [To point the antenna \(BGAN\)](#) on page 16.

Battery

The EXPLORER 710 comes with a rechargeable battery, which is easily inserted. The battery is automatically recharged when power is applied to the EXPLORER 710. The Status indicator shows that the battery is charging. See [Status indicator](#) on page 108.

Time between recharging depends on the use. The display shows estimated time left for the battery.

SIM card

The EXPLORER 710 requires a SIM card to go online. Without a SIM card you can still configure the terminal and you may be able to make emergency calls if the network allows it, but you cannot make normal calls nor access the internet.

SIM lock: The supplier may have locked the SIM card to a specific provider. For further information, contact your supplier.

To get started

This chapter describes:

- [To unpack and assemble the EXPLORER 710](#)
- [Cable connections](#)
- [To start up the EXPLORER 710](#)
- [To connect to the WLAN interface](#)
- [To connect to the LAN interface](#)
- [To connect your phone to the EXPLORER 710](#)
- [To make the first call or data session](#)
- [Fixed antenna installation](#)

To unpack and assemble the EXPLORER 710

Initial inspection

Inspect the shipping carton immediately upon receipt for evidence of damage during transport. If the shipping carton is severely damaged or water stained, request that the carrier's agent be present when opening the carton. Save the carton packing material for future use.



WARNING! To avoid electric shock, do not apply power to the system if there is any sign of shipping damage to any part of the front or rear panel or the outer cover. Read the safety summary at the front of this manual before installing or operating the system.

After unpacking the system, inspect it thoroughly for hidden damage and loose components or fittings. If the contents are incomplete, if there is mechanical damage or defect, or if the system does not work properly, notify your dealer.

What's in the delivery

The following items are included in the delivery:

- EXPLORER 710 terminal including transceiver, antenna and antenna cable
- Battery pack
- AC/DC adapter
- Getting started kit including:
 - Ethernet/ISDN cable, 2 m screened
 - Getting started booklet

The EXPLORER Connect app for smartphones

If you want to use your smartphone with the EXPLORER 710, install the **EXPLORER Connect** app, which is available for iPhone at the Apple Store and for Android phones at Google Play. The EXPLORER Connect app provides the following options from the main menu:

Tile	Function
Satellite Phone	Use your phone as a satellite phone when connected to the EXPLORER 710
Terminal Access	Start and stop data connections and access all settings of the EXPLORER 710
Pointing	Activate the pointing process for the EXPLORER 710 towards the BGAN satellite
Dashboard	See the terminal and connection status

To open the transport latch

The EXPLORER 710 has a transport latch, securing the transceiver and antenna during transport.

1. Lift the transport latch to open the terminal.
2. Flip up the antenna module.
You can now access the keypad and connectors on the EXPLORER 710.

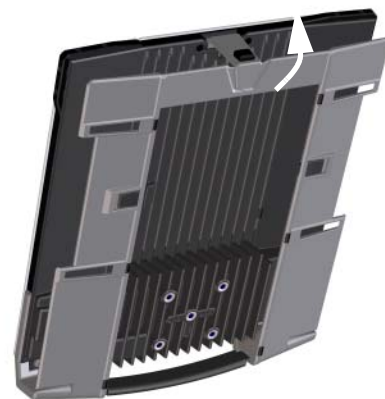

To detach the antenna (optional)

You have two options for using the EXPLORER 710 antenna:

- **Attached.** You can go through the pointing process with the antenna and transceiver attached as one unit. This means you have to move the entire terminal in order to point the antenna towards the BGAN satellite. If you choose this option, make sure you connect all cables including the short antenna cable, and enter the PIN, before pointing the antenna. If not, you may accidentally move the antenna when you connect cables or enter the PIN.
- **Detached.** You can detach the antenna module and use it as a separate antenna. With the antenna separated from the transceiver, it is easier to use the transceiver without accidentally moving the antenna. Also, you can choose the optimum location for the antenna while keeping the transceiver in a more comfortable location.

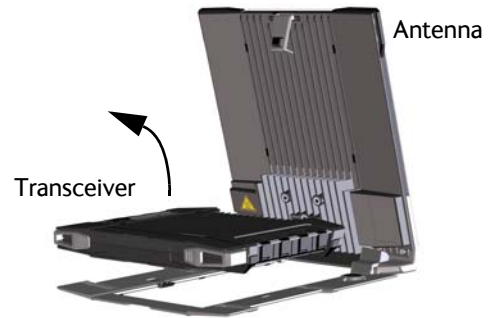

Important

Do **not** place the transceiver in front of the antenna module!
The antenna emits radio frequency energy, which can affect the transceiver.

To detach the antenna, do as follows:

1. Locate the slide locks on the bottom of the terminal.
2. Press and slide the locks outwards while lifting the transceiver to release it from the antenna bracket.



3. Remove the transceiver from the antenna bracket.

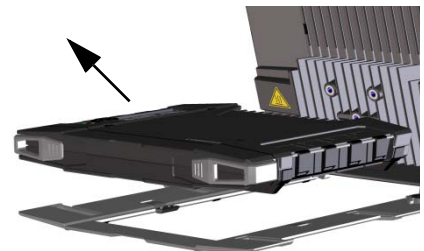

4. To move the antenna and transceiver further apart, disconnect the short antenna cable and connect a longer antenna cable between the antenna and the transceiver.

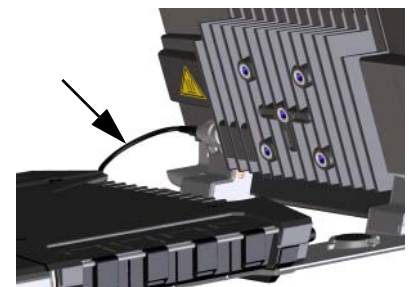

To insert the SIM card

The SIM card is provided by your Airtime Provider. Insert the SIM card as follows:

1. Locate the SIM slot on the same side where the battery is inserted.
2. Insert the SIM card into the SIM slot with the chip side facing up.
3. Press gently until it clicks.
4. Slide the lock in front of the SIM slot.



To insert the battery

Note

The battery should not be partially charged too often. For further information on the battery, see [Maintenance](#) on page 99.

Do as follows:

1. Insert the battery so that the connector fits into the battery slot, indicated in the figure.
2. Press gently until it locks.



Note

Before using the terminal the first time: to ensure accurate information on the battery capacity you should fully charge, then fully discharge the battery, and finally recharge the battery while it is inserted in the terminal. The EXPLORER 710 can be used during the discharging process, but the remaining battery capacity may not be displayed correctly.

For information on how to recharge the battery, see [To recharge batteries](#) on page 99

To remove the battery

Note For protection of the transceiver, always leave the battery inserted. Only remove the battery to replace it.

To remove the battery, do as follows:

1. If the transceiver and antenna are attached, open the transport latch and detach the antenna as described in [To detach the antenna \(optional\)](#) on page 10.
2. On the transceiver, open the battery latches as shown.
3. Remove the battery.

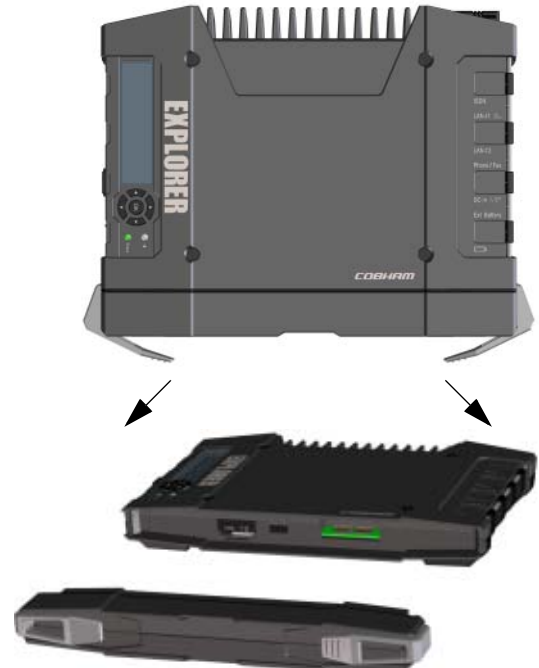

To remove the SIM card

To remove the SIM card, first remove the battery as described in [To remove the battery](#) in the previous section.

Note When the SIM card is removed you cannot make calls or data sessions, but you can still use the display menu system and the built-in web interface to set up the terminal.

Remove the SIM card as follows:

1. Slide the lock aside to open the SIM slot as shown.
2. Gently press the SIM card and let it pop out of the slot.
3. Remove the SIM card.

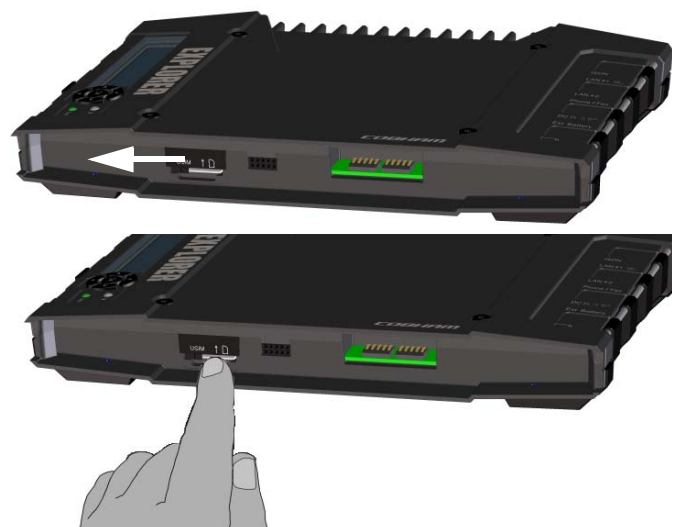

Cable connections

Connectors

The connector panel is placed on the side of the EXPLORER 710 and has the following connectors:

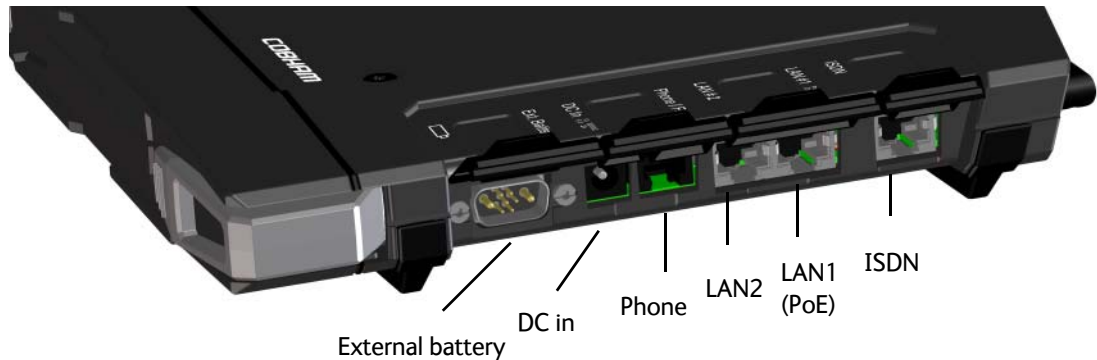

- 1 **Ext battery** connector for connecting an **extra EXPLORER 710 battery**. See [To connect an extra, external EXPLORER 710 battery](#) on page 100.
- 1 **DC power input** connector for 10 - 32 VDC. See [To connect power](#) on page 14.
- 1 **Phone** connector. See [To connect an analogue phone](#) on page 23.
- 2 **LAN** connectors, one with **PoE**. See [To connect to the LAN interface](#) on page 20 and [To connect a phone using LAN or WLAN](#) on page 21.
- 1 **ISDN** connector. See [To connect an ISDN phone or modem](#) on page 24.

Apart from the connectors in the connector panel, there is:

- 1 **USB (Host)** connector placed next to the Power button. The USB (Host) connector is used for the following purposes:
 - Charge phones or tablets (up to 2 A). See [To charge your smartphone or tablet](#) on page 40.
 - Recovery update of software. See [To update software with USB](#) on page 97.
 - Connect an EXPLORER Cellular Modem to obtain a cellular network connection as an alternative to the BGAN network. See [Optional: To set up cellular network for data](#) on page 94.
- 1 **antenna** connector for connecting the antenna module of the EXPLORER 710. See the next section.



To connect the antenna

The antenna cable is connected at delivery.

Note

If you want to use the antenna separated from the transceiver, use a longer antenna cable and remove the transceiver from the antenna bracket. See the [To detach the antenna \(optional\)](#) on page 10.

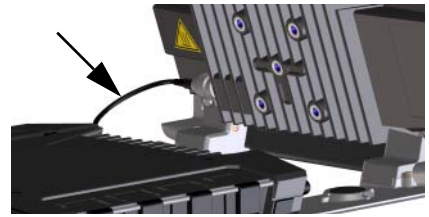

To connect power

When you connect external power to the DC input, the battery is charged while maintaining normal operation.

DC input

Refer to [Technical specifications](#) on page 114 for specifications and pin-out for the DC Power input.

To power the terminal or to charge the battery, connect one of the following external power sources to the DC input:

- 10-32 VDC
- The supplied AC/DC adapter connected to 100-240 V Mains
- A solar panel (min. 65 W, 10-32 VDC)

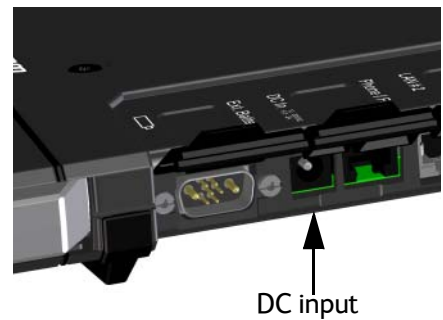

To start up the EXPLORER 710

Automatic power up

The default behaviour of the EXPLORER 710 is to power up automatically when you connect external power. If you wish, you can change this power up mode, so that the EXPLORER 710 is only powered if the Power button is pressed.

For further information on power up mode, see [Automatic power up](#) on page 41.

To switch the EXPLORER 710 on or off

1. Slide and hold the power button until the **Status** indicator lights up. This may take some seconds.
2. When the **Status** indicator flashes slowly or is constant green, and the display shows **Ready**, the terminal is ready for use.
3. To switch off, hold the power button until the **Status** indicator flashes yellow. This may take some seconds.



To enter the SIM PIN

Note

You may not need a SIM PIN for your terminal. If you are asked for a PIN and you select **Cancel**, you cannot communicate on the network, but you can access all terminal settings.

To enter the SIM PIN using the display and keypad, do as follows:

1. When the display shows **Enter PIN?**, highlight the text using the arrow keys and press **OK**. If you select **Cancel**, the startup procedure is continued, but you will not be able to make calls or data sessions over the satellite network. See the previous section.
2. Press ▼ or ▲ a number of times until the first digit is correct.
3. Press **OK** to go to the next digit. The previous digit is indicated by a *.
4. After pressing **OK** to enter the last digit, press **OK** again to apply the PIN.



For an overview of the display and keypad, see [Display and keypad](#) on page 5.

For information on how to enter the PIN in the web interface, see [To enter the SIM PIN](#) on page 47.

To access the network

BGAN or cellular network

The EXPLORER 710 is a BGAN terminal. However, you have the option of connecting an EXPLORER Cellular Modem to the USB interface of the EXPLORER 710, making it possible to use the cellular network when it is available. See [Optional: To set up cellular network for data](#) on page 94.

If you are going to use the BGAN network, you must first point the antenna in the direction of the satellite and find the best possible signal strength. See the next sections for details.

To point the antenna (BGAN)

Note You can choose to cancel pointing. In this case you cannot communicate on the BGAN network, but you can access all terminal settings.

Before pointing

Before pointing the antenna you can use the coverage map below to find your approximate location in relation to the satellites. Then you can use the compass to find the pointing direction to the closest satellite.

The 3 Inmarsat satellites are positioned above the equator, at the centre of each “footprint”.

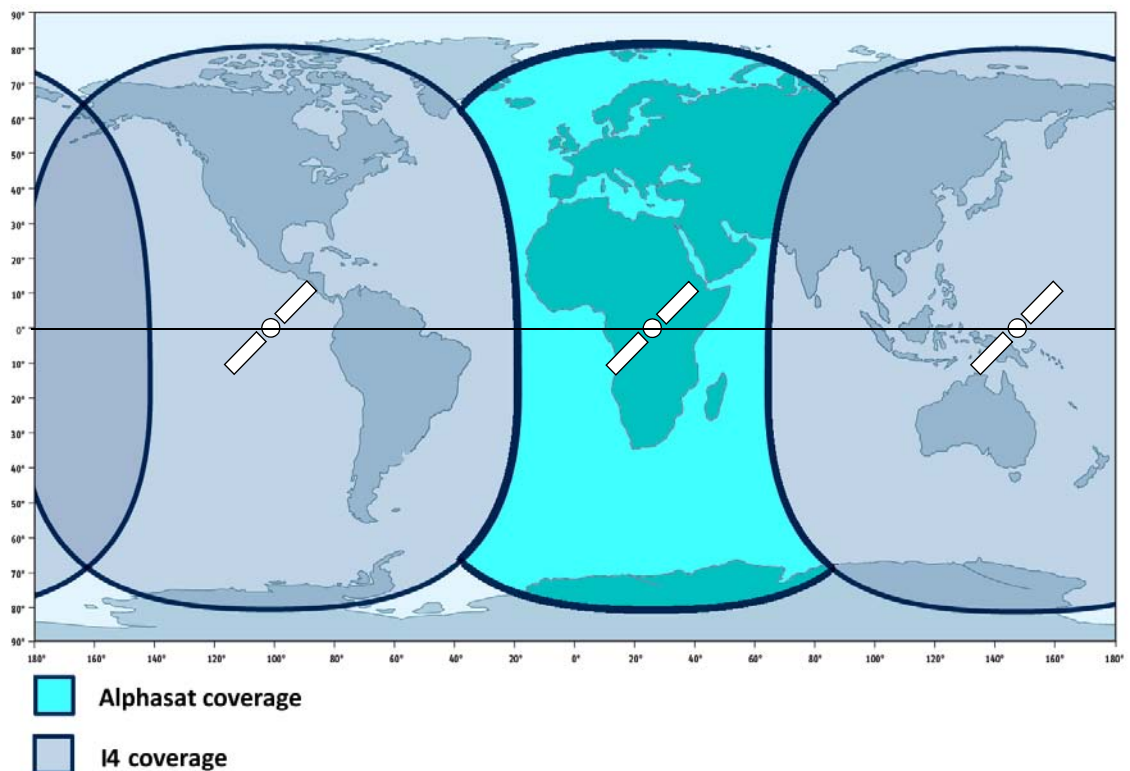

To enable or disable the pointing sound:

1. Select  in the display.
2. Select **Settings > Audio indication > pointing**.
3. Select **On** or **Off**.

The registration procedure (BGAN)

The display shows the progress as follows:

- **Searching:**
The EXPLORER 710 searches for the network operator. Note that the search procedure can be very short, so you may not see this text.
- **Registering:**
The EXPLORER 710 is registering itself on the network.
If the GNSS position has not yet been acquired at this point, the display may show **No position**.
- **Ready** (or other status information):
Ready means the EXPLORER 710 is registered on the network and is ready to go online. If there is any other status information to show, e.g. if a call or data session is active or there is a warning, the display will show that instead.

Note

By default, if you want to use a data connection, you must manually start it from the display or from the web interface. See [To make the first call or data session](#) on page 25. However, you can set up the EXPLORER 710 to automatically connect to the Internet when you connect equipment to the LAN or WLAN interface. See [To set up the connection mode](#) (step 4. on page 68).

To repoint the antenna

You may need to point the antenna again later, e.g. if the terminal has been moved or the signal is blocked.

To start the pointing process again, do as follows:

Display: Select  and select **Point now**. Then go through the pointing process as described in the previous section, and press **OK** in the keypad when the signal strength is OK.

web interface: Select  (Control panel) > **Point now**. Then go through the pointing process as described in the previous section and click **Accept** in the web interface or **OK** in the display.

Pointing in EXPLORER Connect app

To start the pointing procedure from the EXPLORER Connect app, do as follows:

1. Select **Pointing** from the EXPLORER Connect app.
2. If the pointing process is not already started, tap **Start**.
The signal strength is shown on the screen.
3. Turn and tilt the antenna slowly as described in the previous sections until you have obtained the highest possible signal strength.
4. Tap **Accept**. The terminal will now try to register on the BGAN network.

To connect to the WLAN interface

To connect to the WLAN interface, do as follows:

1. Check that WLAN is enabled in your EXPLORER 710. The top line of the display shows which interfaces are enabled.
2. If your device is not close to the EXPLORER 710, turn the WLAN antenna of the transceiver into an upright position.
3. Place your WLAN-enabled device (computer, tablet or smartphone) close to the EXPLORER 710, but **not** in front of the antenna.
4. On your device, search for available WLAN networks.
5. Select the EXPLORER 710 WLAN access point when it appears in your list of available wireless networks. The default name is **EXPLORER710**.
6. You may have to enter a password.
By default, the password is the **serial number** of your EXPLORER 710 and the encoding type is **WPA2**. You can find the serial number in the display menu under **Properties > Hardware > Unit serial number**.



Your device should now be connected to the EXPLORER 710. The WLAN icon in the display and in the web interface shows the number of WLAN-connected devices (example: Wi-Fi^2). If you want to connect to the Internet, you must start a data connection, see [To start or stop a data connection using the display](#) on page 27. The status text in the display shows when there is an active data connection.

You are now ready to browse the Internet, check e-mails, send files etc.

Calls: If you want to use WLAN to make calls over the BGAN network, you must have a SIP client installed on your smartphone. See [To connect a phone using LAN or WLAN](#) on page 21.

For information on how to configure the WLAN interface, see [WLAN interface setup](#) on page 54.

To connect to the LAN interface

Before connecting to the LAN interface

The EXPLORER 710 has two LAN connectors. If more than one LAN or WLAN user is connected to the EXPLORER 710, the terminal should be in Router mode (default). Refer to [To set up the connection mode](#) on page 66.

To connect to the LAN interface, use a shielded cable mounted with an RJ-45 connector.

For specifications, refer to [LAN interface, 2-port](#) on page 119.

For the LAN interface to work without any further setup, the computer must be set up to obtain an IP address and a DNS server address automatically.

To connect to the LAN interface

This section does not describe configuration of the LAN interface. For information on configuration, see [LAN interface setup](#) on page 54.

To connect to the LAN interface, do as follows:

1. Connect the LAN cable to the network interface of your computer.
A suitable cable is provided with your EXPLORER 710.
2. Connect the other end of the cable to one of the LAN connectors on the EXPLORER 710.

Important

The ISDN interface and the LAN interface use the same connector type. Be careful not to connect to the wrong interface.



Your computer should now be connected to the EXPLORER 710. If you want to connect to the Internet, you must start a data connection, see [To start or stop a data connection using the display](#) on page 27. The status text in the display shows when there is an active data connection.

To connect your phone to the EXPLORER 710

To connect a phone using LAN or WLAN

Your smartphone or IP phone can be set up to make and receive calls over the BGAN network, using the terminal's phone number. You can also make local calls to other handsets connected to the EXPLORER 710.

Note Make sure your phone has an integrated SIP client. Cobham SATCOM offers the **EXPLORER Connect** app with a built-in SIP client that is ready to use with the EXPLORER 710. You can also find other SIP applications on the Internet.

To connect your smartphone for making calls

To use your phone to make calls through the EXPLORER 710 using WLAN, do as follows:

1. Start up the EXPLORER 710 terminal.
2. Connect your smartphone to the wireless access point of the EXPLORER 710.
See [To connect to the WLAN interface](#) on page 19.
3. Start the **EXPLORER Connect** app and select **Satellite Phone** (or start another SIP application). If it is the first time you use the EXPLORER Connect app, you must select **Register** when prompted.



Note If you are using the EXPLORER Connect app for the first time, make sure that "Enable Reception of Incoming Calls" is selected in the settings page. This is to prevent your smartphone from closing the WLAN connection when not in use. This is necessary in order to be able to receive calls on your smartphone.

You should now be ready to make and receive calls over BGAN. For details on **initial setup** of your smartphone and the EXPLORER 710, see

- The documentation for your handset
- [First time SIP setup](#) on page 22
- [To manage IP handsets or smartphones](#) on page 61

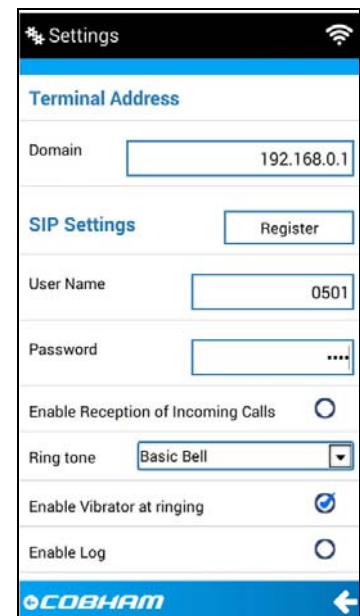

To connect a wired IP handset for making calls

Note | Make sure your IP handset complies with PoE class 2 (7 W).

For details on **initial setup** of your IP handset and the EXPLORER 710, see

- The documentation for your handset
- [First time SIP setup](#) on page 22
- [To manage IP handsets or smartphones](#) on page 61

To connect a wired IP handset, do as follows:

1. Start up the EXPLORER 710 terminal.

Note | Make sure PoE is enabled in the terminal. See [LAN interface setup](#) on page 54.

2. Connect the LAN cable between the IP handset and the connector **LAN #1** on the EXPLORER 710.

When the IP handset is powered and ready, you should now be able to make and receive calls over BGAN.

First time SIP setup

If you do not have the EXPLORER Connect app and it is the first time you connect your phone to the LAN or WLAN interface for making calls, you must first set up the SIP server details in your smartphone. For information how, see the user documentation for your smartphone and for the SIP application. You may be asked to enter some of the following details:

- SIP server address and port: Default address: 192.168.0.1, Port: 5060
- User name: Local no. in EXPLORER 710 (0501 to 0516)
- Password: Default same as user name
- Codec priority: Highest priority codec type: G.711

Note | The user name and password must match the IP handset settings in the web interface of the EXPLORER 710. See [To manage IP handsets or smartphones](#) on page 61.

To connect an analogue phone

Before connecting to the Phone interface

To connect a phone to the Phone connector, you need an analog telephone cable with an RJ-11 connector. For specifications and pin-out, refer to [Phone interface](#) on page 117.

To connect to the Phone interface

Do as follows:

1. Connect the cable to your phone.
2. Connect the other end of the cable to the Phone connector on the EXPLORER 710.

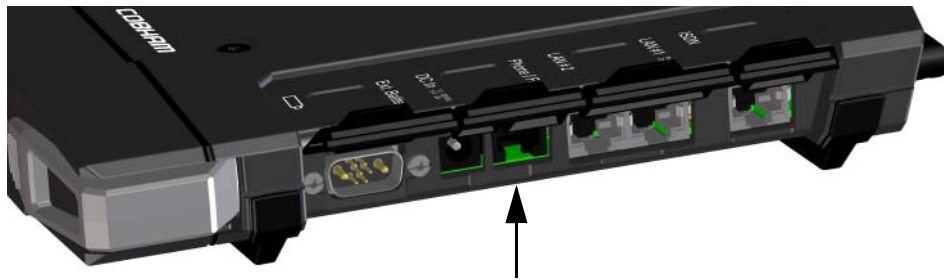

3. Power up the EXPLORER 710 and point the antenna as described in [To point the antenna \(BGAN\)](#) on page 16.
4. Check the connection by making a phone call.
See [To make or receive a phone call with EXPLORER 710](#) on page 38.

If connection fails, check that the interface is enabled in the EXPLORER 710. If the analogue phone icon is crossed out in the display main screen, the interface is disabled. See [To enable or disable an interface](#) on page 30.

To connect an ISDN phone or modem

Before connecting to the ISDN interface

To connect a phone or modem to the ISDN connector, you need an ISDN cable with an ISDN connector. For specifications and pin-out, refer to [ISDN interface](#) on page 118.

To connect to the ISDN interface

The ISDN interface supports connection of up to 4 devices. However, if you are going to connect more than one device, the devices must be self-powered. The ISDN interface can supply maximum 1 W.

The BGAN Core network presently only supports one 64 kbps ISDN channel per subscription.

Do as follows:

1. Connect the ISDN cable to your phone or modem.
2. Connect the other end of the cable to the ISDN connector on the EXPLORER 710.



3. Power up the EXPLORER 710 and point the antenna as described in [To point the antenna \(BGAN\)](#) on page 16.
4. Check the connection by making a phone call.
See [To make or receive a phone call with EXPLORER 710](#) on page 38.

If connection fails, check that the ISDN interface is enabled in the EXPLORER 710.

If the ISDN icon is crossed out in the display main screen, the interface is disabled. See [To enable or disable an interface](#) on page 30.

To make the first call or data session

To make the first call

After entering the PIN, pointing the antenna and connecting your equipment, you are ready to make or receive the first call. The following sections provide a short guide to making calls. For more detailed information, see [To make or receive a phone call with EXPLORER 710](#) on page 38.

For details on how to connect your phone, see

- [To connect a phone using LAN or WLAN](#) on page 21
- [To connect an analogue phone](#) on page 23
- [To connect an ISDN phone or modem](#) on page 24

To make a call from the EXPLORER 710

To make a call from a phone connected to the EXPLORER 710, dial

00 <country code> <phone number> followed by **#** or off-hook key.

Example: To call Cobham SATCOM in Denmark (+45 39558800) from an analogue phone, dial **00 45 39558800 #**

To make a call to the EXPLORER 710

To make a call to a phone connected to the EXPLORER 710, dial

+ <Mobile number>

- **+** is the prefix used in front of the country code for international calls.
- **Mobile number:** The mobile number of the EXPLORER 710 you are calling. The first part of the mobile number is always 870, which is the “country code” for the BGAN system. For information on your mobile numbers, refer to your airtime subscription.

Note | There are two voice numbers, one for 3.1 kHz audio and one for Standard voice.

Example: If you are calling from Denmark and the mobile number for 3.1 kHz audio is 870782112345 on your EXPLORER 710, and you want to make a call to the EXPLORER 710 using 3.1 kHz audio, dial **00 870 782112345**.

To make the first data connection (LAN)

Note

For the LAN interface to work without any further setup, your computer must be set up to obtain an IP address and DNS server address automatically.

Do as follows:

1. Connect a LAN cable between your computer and LAN#1 or LAN#2 on the EXPLORER 710.
2. When power up and pointing is completed, you can start a Standard data connection from the display or from the web interface. See [To start or stop a data connection using the display](#) on page 27.

The status text in the display shows the active connection.

To make the first data connection (WLAN)

To connect to the WLAN interface, do as follows:

1. Check that WLAN is enabled in your EXPLORER 710. The top line of the display shows which interfaces are enabled. If WLAN is disabled, use the keypad arrows to highlight the WLAN icon and OK to enable WLAN.
2. If your device is not close to the terminal, turn the WLAN antenna of the transceiver into an upright position.
3. Place your WLAN-enabled device (computer, tablet or smartphone) close to the EXPLORER 710, but **not** in front of the antenna.
4. On your device, search for available WLAN networks.
5. Select the EXPLORER 710 WLAN access point when it appears in your list of available wireless networks. The default name is **EXPLORER710**.
6. If you are prompted, enter the password. By default, the password is the **serial number** of your EXPLORER 710 and the encoding type is **WPA2**. You can find the serial number in the display menu under **Properties > Hardware > Unit serial number**.
7. When your device shows that it is connected to the EXPLORER 710, you can start a data connection as described in the next section.



For information on how to configure the WLAN interface, see [WLAN interface setup](#) on page 54.

To start or stop a data connection using the display

By default, you must manually start data connections. However, you can enable automatic activation in the web interface. See [To set up the connection mode](#) on page 66.

To start a data connection

Do as follows:

1. Start up the terminal as described in [To start up the EXPLORER 710](#) on page 15.
2. Connect your equipment to the interface you want to use.
3. Use the arrow keys to highlight the connection icon in the bottom left corner of the display.



4. Push **OK** to see the available connection packages.
5. Go to the connection package you want to start or stop.
6. Push **OK** on the keypad.
7. Push **OK** again to start the connection.

Note It may take some time to start up the connection. The display shows the status while the connection is being established and the number on the connection icon changes from 0 to 1 when the connection package is up and running. If the connection fails, the display shows an error message.

You should now be able to access the Internet from you connected device.

To stop a data connection

Do as follows:

8. Use the arrow keys to highlight the connection icon in the bottom left corner of the display.
9. Push **OK**. The running connection is displayed with Stop highlighted.
10. Push **OK** on **Stop** to stop the connection.

For information on how to start and stop data connections with the web interface, see [To control data connections from web interface \(BGAN\)](#) on page 49.

For information on how to configure the data connections, see [To set up your data connection packages \(BGAN\)](#) on page 71.

Fixed antenna installation

You can keep the EXPLORER 710 antenna in a fixed position, using the Pole mount kit for EXPLORER 710.

Do as follows:

1. Separate the antenna from the transceiver as described in [To detach the antenna \(optional\)](#) on page 10.
2. Mount the EXPLORER 710 antenna on a pole or a wall, for example using the Pole mount kit.
3. Connect the antenna cable between the antenna and the transceiver.
4. Start up the EXPLORER 710 and point the antenna as described in [To point the antenna \(BGAN\)](#) on page 16.
5. Accept the signal strength by pressing **OK** on the EXPLORER 710 keypad.
6. Fasten the EXPLORER 710 antenna in the pointed position.

You only have to point the antenna once, when you mount it. Using a computer connected to the EXPLORER 710, you can set up the EXPLORER 710 to skip pointing at power up. Refer to [Pointing at start-up](#) on page 66.

To use the EXPLORER 710

This chapter describes daily use and basic setup using the display. For information on the web interface, see [To use the web interface](#) on page 43.

This chapter describes:

- [BGAN or cellular network](#)
- [User interfaces](#)
- [Data connection with computer, smartphone or tablet](#)
- [Phone connection](#)
- [To see alerts](#)
- [Terminal settings in display](#)
- [To see properties of the EXPLORER 710 in the display](#)
- [Tracking](#)

BGAN or cellular network

The EXPLORER 710 is a BGAN terminal. However, you have the option of connecting an EXPLORER Cellular Modem to the USB interface of the EXPLORER 710, making it possible to use the cellular network when it is available. See [Optional: To set up cellular network for data](#) on page 94.

User interfaces

The following user interfaces are available when using the EXPLORER 710

- Phone
- ISDN
- LAN
- WLAN
- USB (Host)

To enable or disable an interface

To enable or disable interfaces with the display and keypad

Note | By default, only the LAN interface is enabled. However, you can enable or disable each of the interfaces independently.

To enable or disable an interface, do as follows:

1. In the top of the display, locate the interface you want to enable or disable.

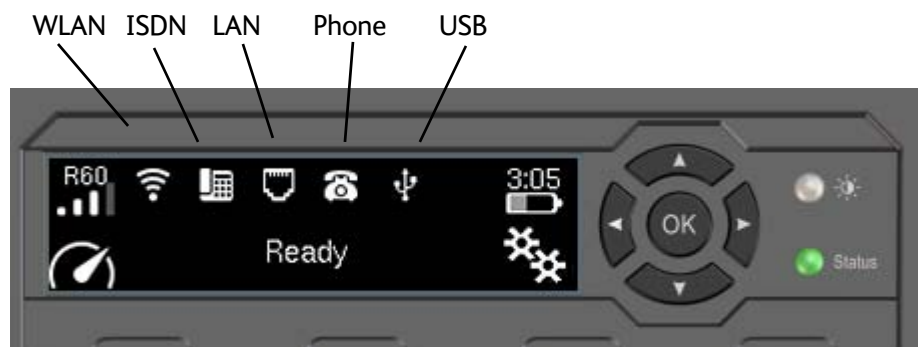

2. Use the arrow keys on the keypad to highlight the interface you want to enable or disable.
3. Press **OK** to toggle between enable and disable. The interface is greyed and crossed out when disabled.



Note | It may take some seconds to enable an interface. When the icon stops pulsating and is no longer crossed out, the interface is enabled.

To enable or disable interfaces with the web interface

Note | By default, only the LAN interface is enabled. However, you can enable or disable each of the interfaces independently.

To enable or disable an interface using the web interface, do as follows:

1. Connect your smartphone, tablet or computer to the EXPLORER 710, using the LAN or WLAN interface. See:
 - [To connect to the LAN interface](#) on page 20
 - [To connect to the WLAN interface](#) on page 19
2. To access the web interface, open your browser and type the IP address of your EXPLORER 710¹ (default IP address: 192.168.0.1). For further information on the web interface, see [To use the web interface](#) on page 43.

1. You find the IP address in the display menu system by entering the menu and selecting **Properties > IP address**.

3. When the web interface opens, click  (Control panel) from the bottom right corner of the page.
4. Locate the icon with the interface you want to enable or disable.
 - If the icon is grey with a line across, the interface is **disabled**.
 - If the icon is blue, the interface is **enabled**.
5. To enable or disable the interface, click the icon for the interface and select or clear **Enable**.
6. Click **Save**.

Note

It may take some seconds to enable the interface. When the icon changes to the **enabled** (blue) icon, the interface is enabled.

Data connection with computer, smartphone or tablet

Overview

The following interfaces are available for connecting computers, smartphones or tablets:

- WLAN
- LAN

To choose an interface for data connection

The following table shows some characteristics of each interface to help you choose the right interface for your application. For information on how to connect your equipment, see [To connect to the WLAN interface](#) on page 19 and [To connect to the LAN interface](#) on page 20.

Interface	Power consumption	Amount of setup	Range
WLAN	High	Some setup necessary on your WLAN device and in the web interface of the EXPLORER 710	Wireless connection. Up to 100 m depending on the transmitter in the computer and on the transmission conditions.
LAN	High	None (or very little)	Up to 100 m of cable

Router function

The terminal has a router function which routes traffic between the local network connected to the terminal and up to 11 BGAN network connections (also called PDP contexts on the BGAN network).

The router contains NAT (Network Address Translation) which allows sharing of a public IP address between a number of local network users.

Standard or Streaming data

The BGAN network supports different classes of data connection to the Internet. The main classes are **Standard data** and **Streaming data**.

- Using a **Standard data** connection, several users can share the data connection simultaneously. This type of connection is ideal for TCP/IP traffic such as e-mail, file transfer, and Internet and intranet access.
The user pays for the amount of data sent and received.
- Using a **Streaming data** connection, you get an exclusive, high-priority connection, ensuring seamless transfer of data. This type of connection is ideal for time critical applications like live video over IP.
The user pays for the duration of the connection (per minute charge).

To start or stop a data connection

By default, you must manually start data connections. However, you can enable **automatic activation** in the web interface. See [To set up the connection mode](#) on page 66.

Display: For information on how to start and stop data connections using the display, see [To start or stop a data connection using the display](#) on page 27.

Web interface: For information on how to start and stop data connections with the web interface, see [To control data connections from web interface \(BGAN\)](#) on page 49.

Configuration: For information on how to configure the data connections, see [To set up your data connection packages \(BGAN\)](#) on page 71.

Bonding of terminals

You can connect two EXPLORER 710 terminals to obtain a higher bandwidth. This is useful for UDP connections such as video and audio transmissions.

Note A bonding server must first be set up, in order receive and “reassemble” the two signals into one at the receiving end. You must know the server name, user name and password in order to set up the EXPLORER 710 terminals used for bonding.
You find the Bonding server application in the Cobham SATCOM Self Service Center at www.cobham.com/communications-and-connectivity/satcom, select **Service and Support > AVIATOR, EXPLORER, SAILOR Service and Support** and then **24-7 Self Service Centre / Technical Downloads**.

Do as follows:

1. Configure the bonding settings on both terminals as described in [To set up channel bonding](#) on page 69. Make sure bonding is **enabled** for both terminals.
2. Make sure both terminals are in Router mode (see [To set up the connection mode](#) on page 66).
3. Connect a LAN cable between the two terminals, using the LAN connectors.
4. Switch on one of the two EXPLORER 710 terminals.

5. After about 20 seconds, switch on the other EXPLORER 710 terminal. The two terminals will now find each other and decide which terminal is “master” and which one is “slave”.
6. When the two terminals are ready, the display on the slave terminal reads **Bonding slave mode**. The master terminal automatically enables bonding connection packages in the display and in the web interface.

Note | When you are using the bonding function, you can only start data connections from the master terminal.

7. Connect your user equipment to the master terminal.
8. From the master terminal, start the bonding connection package you want to use. For details, see [To start or stop a data connection](#) on page 32 or [To control data connections from web interface \(BGAN\)](#) on page 49.

When the display of the master terminal shows that the bonding connection package is running, you can start transmission from your connected equipment.

Note | The MTU (Maximum Transmission Unit) for bonding connections is 1400 Bytes. The connected equipment (video codecs etc.) must be set up to match this.

If, at a later stage, you want to use the “slave” terminal without the bonding function, you must disconnect the two terminals and switch the “slave” terminal off and on again.

PPPoE (Point-to-Point Protocol over Ethernet)

Note You cannot see in the display nor in the web interface if a PPPoE connection is active!

Overview

You can establish a PPPoE connection to the BGAN network using the EXPLORER 710 system. Use PPPoE if you want to control your connection independently of the web interface.

Possible applications are:

- Connecting a router
- Connecting broadcast equipment, optionally through a PC
- Establishing a Picocell for the use of cell phones

The drawing shows connections managed through PPPoE and web interface respectively.

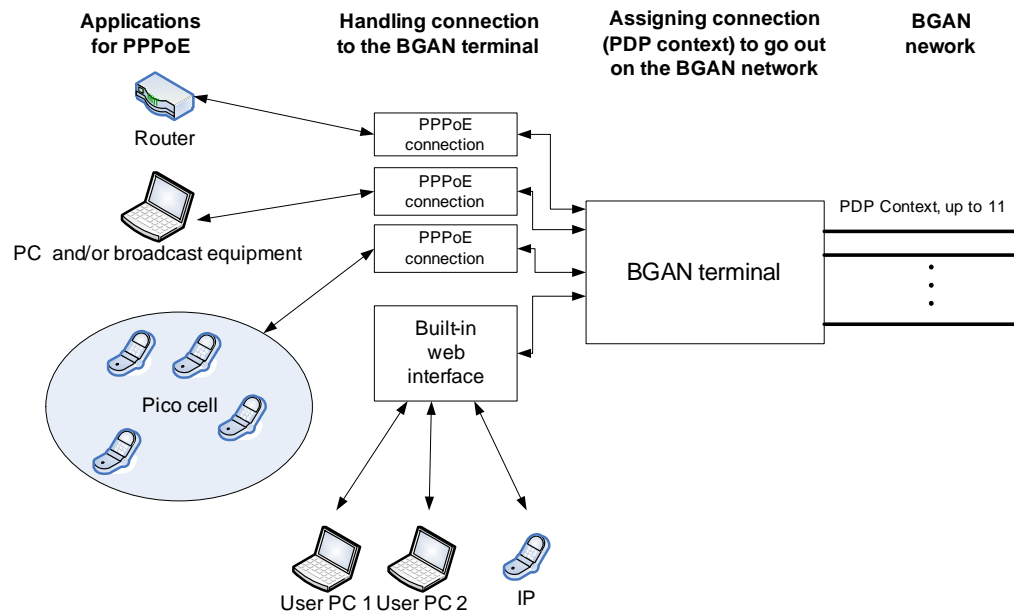

Configuring the connected equipment for PPPoE

How to configure your equipment depends on the type of equipment. Refer to the user documentation of the equipment. As a minimum, you need to configure the following parameters in your equipment in order to make PPPoE work with the terminal:

- User name and password.

The user name and password can be left blank (or insert user name: void and password: void). Then the registration on the Access Point is most commonly done in such a way that the data connection is established with a dynamic IP address from the airtime provider. To request a static IP (if subscribed to) from the Access Point you must type in the user name and password from your airtime subscription.

Note for MAC OS: User name and password are required. Use user name void and password void. This works for some ISPs. Contact your airtime provider for further information.

- For setups that have a check box for “Enable LCP extensions”, deselect this.

No further configuration is needed to make a Standard IP data connection to the Internet.

See the table below for information on how to configure specific services for your PPPoE connection.

If you need a certain service, for example a Streaming class, you must type in a specified text string when asked for a service name. The following table shows the service names supported by the terminal.

Text to type in the Service Name field	Function
(Blank)	Initiates a Primary Standard Data connection (default)
XBB:BACKGROUND	Initiates a Primary Standard Data connection (same as blank)
XBB:STREAM32K	Initiates a Primary Streaming 32 kbps connection
XBB:STREAM64K	Initiates a Primary Streaming 64 kbps connection
XBB:STREAM128K	Initiates a Primary Streaming 128 kbps connection
XBB:STREAM176K	Initiates a Primary Streaming 176 kbps connection
XBB:STREAM256K	Initiates a Primary Streaming 256 kbps connection
XBB:X-STREAM	Initiates a Primary X-Stream connection (from a minimum of 384 kbps up to approximately 450 kbps)
XBB:HDR_STREAM416K	Initiates a Primary Streaming 416 kbps (½HDR) connection
XBB:HDR_STREAM896K	Initiates a Primary Streaming 896 kbps (HDR) connection
XBB:HDR_STREAM416K_64K	Initiates a Primary Streaming 416 kbps (½HDR) upload and 64 kbps download connection
XBB:HDR_STREAM896K_64K	Initiates a Primary Streaming 896 kbps (HDR) upload and 64 kbps download connection
XBB:<AT String>	This allows the PPPoE clients to enter a full AT context activation string. Examples: XBB:AT+CGDCONT=1,ip,"bgan.inmarsat.com" XBB:AT+CGEQREQ=1,1,64,64,64,64

To access the terminal using AT commands

1. Connect your computer to the EXPLORER 710 terminal.
You may connect directly to the terminal or use a remote connection as described in the next sections.
2. On the connected computer, start a Telnet session.
3. Select TCP/IP and type in the IP address and port number.
 - For **local connection**, use the local IP address of the EXPLORER 710 (default 192.168.0.1) and port number 5454.
 - For **remote connection**, use the external IP address of the terminal ([step 3](#) in the next section). The port number for AT commands is normally 5454 but is defined in the Remote management page under AT commands (see [Remote management](#) on page 87).
4. When the connection is established, type in your AT commands.

To access the terminal from a remote location

To prepare the terminal for remote management

There are three steps you must go through before you can access the terminal from a remote location:

1. Set up the terminal for control from a remote location as described in [Remote management](#) on page 87.
2. Activate a data connection in one of the following ways:
 - Remote start of a data connection with an SMS, see [Remote access with SMS](#) on page 88 and [To activate a data connection with an SMS](#) below.
 - Automatic activation of a Standard data connection, see [step 4](#) in [To set up the connection mode](#).
 - Manual activation of a data connection, see [To start or stop a data connection](#) on page 32.
3. Note the terminal's external IP address, found in one of the following ways:
 - If you are using SMS activation and you have selected SMS confirmation, you will receive an SMS with the IP address.
 - Otherwise, connect a computer locally to the terminal and start the web interface. The external IP address of the terminal is shown in the startup page in the tile with the connection you started in the previous step.

This is the IP address you must use afterwards to access the terminal.

Note

If Static IP is included in your airtime subscription, we recommend using this static public IP address for the terminal in order to provide easy access to the terminal. To use the static IP address, you must set the APN source to SIM default. For details, see [To change the APN for a connection package](#) on page 72.

To activate a data connection with an SMS

To be able to activate a data connection on the terminal from a remote location, the terminal must be set up as described in [Remote access with SMS](#) on page 88.

Send an SMS to the mobile number of the terminal. The text in the activation SMS must have the following format for activating and deactivating a connection:

- ACTIVATE <name of network user group>:<name of profile> <password>
- DEACTIVATE <name of network user group>:<name of profile> <password>
 - <name of network user group>: **default group**
 - <name of profile> **standard** (presently, only standard is supported)
 - <password> Defined in the web interface under **Advanced > Remote management**.

Example: To activate a connection for remote management with the standard data connection and password=1234567890, send an SMS to the terminal with the text: **ACTIVATE default group:standard 1234567890**

If you have selected SMS confirmation, you receive a response including the IP address to use when you access the terminal from a remote location (see the next two sections).

Example: A confirmation SMS after sending an activation SMS may look like this:
Activation: Succeeded, IP 161.30.181.31

Remote access with the web interface

Note | The web interface may take a long time to load the pages if your Internet connection speed is slow.

After preparing the terminal as described in the previous sections, do as follows to access it:

1. Make sure your remote computer has access to the Internet.
2. On the remote computer, open your web browser.
3. In the address bar of your browser, enter the IP address of the terminal followed by a colon and the port number
http://<ip address>:<incoming port>
 - <ip address> is the address from [step 3](#) in the previous page
 - <incoming port> is the port you defined in [Remote management](#) on page 87

Example: If the IP address of the terminal is 161.30.180.12 and the incoming port number defined in the Remote management page in the web interface is 8080, enter **http://161.30.180.12:8080**.

You should now be connected to the built-in web interface of the terminal.

Remote access with AT commands

After preparing the terminal for remote management as described in the previous sections, access the terminal as described in [To access the terminal using AT commands](#) on page 36.

Phone connection

Call types

Definition

The phone connection can be either a **Standard voice** connection or a **3.1 kHz audio** connection.

- For **outgoing calls**, the call type is **Standard voice** by default. You can change the call type for your call to 3.1 kHz audio by dialling **2*** before the number.
- For incoming calls, you can set up in the web interface which call types you want to receive on the Phone, ISDN or LAN/WLAN interface (IP handset). Only the call types selected for an interface are received on that interface (by default, all call types are accepted).

When receiving calls, the mobile number determines which call type is used. In your airtime subscription you have one number for 3.1 kHz audio and one number for Standard voice. Remember that the call is only received on an interface if the call type used is selected for that interface.

For information on how to set up the call types in the web interface, see [Phone interface setup](#) on page 56.

To make or receive a phone call with EXPLORER 710

Smartphone, analogue phone, ISDN phone or IP handset

First connect your phone to the relevant interface. For further information, see:

- Smartphone: [To connect your smartphone for making calls](#) on page 21
- Analogue phone: [To connect an analogue phone](#) on page 23
- ISDN phone: [To connect an ISDN phone or modem](#) on page 24
- IP handset: [To connect a wired IP handset for making calls](#) on page 22

To make a call from the EXPLORER 710

- To make a call, dial **00 <country code> <phone number>** followed by **#** or off-hook key.

Example: To call Cobham SATCOM in Denmark (+45 39558800), dial **00 45 39558800 #**

If there was an error establishing the connection, the web interface and the display of the EXPLORER 710 show an error message.

To receive a call

By default, all devices connected to the EXPLORER 710 will ring when one of the mobile numbers is called. Note however, that this depends on the call type settings. See [Call types](#) on page 38.

Information on missed calls is stored in the call log. You can see the call log in the web interface (Control panel  > Logs > Call log).

To make a call to the EXPLORER 710

To make a call to a phone connected to the EXPLORER 710, dial + **<Mobile number>**

- + is the prefix used in front of the country code for international calls. This is **00** when calling from countries in Europe and from many other countries.
- **Mobile number.** The first part of the mobile number is always 870, which is the “country code” for the BGAN system. For information on the mobile numbers, refer to your airtime subscription.

Note

There are two mobile numbers, one for **3.1 kHz audio** and one for **Standard voice**.

Local numbers and special functions

Overview

There are a number of local numbers and dialing functions available in the EXPLORER 710.

The following list shows the allocated local numbers and special-purpose numbers for the EXPLORER 710.

Number	Function
00 followed by one of the numbers 1-199 and # or off-hook key	Short dial phone numbers in phone book.
0300 followed by # or off-hook key	Local call to analog phone.
0400 followed by # or off-hook key	Local call broadcast to all ISDN phones.
0 followed by one of the numbers 401-404 and # or off-hook key	Local call to one ISDN phone.
0 followed by one of the numbers 501-516 and # or off-hook key	Local call to one IP handset.
0900 followed by # or off-hook key	Local call broadcast to all handsets.

Apart from the numbers above, the EXPLORER 710 uses the following dialing prefixes:

- **1*** before the phone number will force the connection to use **Standard voice**.
- **2*** before the phone number will force the connection to use **3.1 kHz audio**.
- **#31#** before the phone number will hide the callers phone number to the recipient.
- ***31#** before the phone number will show the callers phone number to the recipient where it would otherwise be hidden, e.g. because the number is an ex-directory number.

To make local phone calls

You can make local calls between phones connected to the EXPLORER 710. For an overview of the available numbers, see the table in the previous section.

To make a local call, dial **<local number>** followed by # or off-hook key.

To charge your smartphone or tablet

To charge your smartphone or tablet, connect it to the USB interface next to the power button on the EXPLORER 710. The connector is a standard USB A connector.



Note

There are two levels of charge current, 0.5 A or 2.0 A. Use the web interface to select the charge current for your device. See [USB interface setup](#).

To see alerts

When an event requiring the attention of the user occurs, the display shows a warning icon . To see a list of active alerts in the display, do as follows:

1. From the display menu, select **Alerts**.
2. Select an alert to see details.

All alerts and other events are logged in the Event log

Terminal settings in display

To adjust the display

To adjust the display brightness and timeout, do as follows:

1. From the display menu, select **Settings > Display**.
2. Select **Brightness** and select the wanted level with **OK**.
3. Select **Settings > Display > Timeout**.
4. Select the period of time the display light should stay on after the last key is pressed.

Automatic power up

The default behavior of the EXPLORER 710 is to power up automatically when you connect external power. If you wish, you can change this power up mode, so that the EXPLORER 710 is only powered if the Power button is pressed. To switch between automatic and manual power up of the terminal, do as follows:

1. From the display menu, select **Settings > Power up mode**.
2. Select **Auto** or **Manual**.
 - Auto: The EXPLORER 710 powers up automatically when external power is applied
 - Manual: The EXPLORER 710 powers up only when the power button is pressed

To change the language in the display

The default language of the display is **English**. You can change the language to **French, German, Russian, Spanish, Chinese** or **Japanese**.

1. From the display menu, select **Settings > Language**.
2. Select the language you want.

To see properties of the EXPLORER 710 in the display

Using the display and keypad, you can see properties of the EXPLORER 710. Do as follows:

1. From the display menu, select **Properties**.
2. Select **IP address** to see the local IP address of the EXPLORER 710.
3. Select **Hardware** to see serial numbers and MAC addresses for the EXPLORER 710.
4. Select **Software** to see the software version of the EXPLORER 710.
5. Select **Conformity** to see a list of the standards to which the EXPLORER 710 conforms.
6. Select **IMEI** to see the IMEI number of the EXPLORER 710.

Tracking

The EXPLORER 710 can be used for tracking purposes. You can set up the terminal to report its position to a server at certain time intervals.

To use the tracking feature you must either set up a tracking server or get a tracking solution from your service provider. The EXPLORER 710 must be set up to match this server. For information how to set up the EXPLORER 710, see [To set up tracking](#) on page 78. Once set up on both sides, the EXPLORER 710 will send position reports to the server as specified.

To use the web interface

This chapter describes how to use the **web interface** or the **Terminal Access** part of the **EXPLORER Connect** app to operate, set up and configure your system. It has the following sections:

- *The EXPLORER Connect app*
 - *The web interface*
 - *To enter the SIM PIN in the web interface*
 - *To point the antenna (BGAN)*
 - *To control data connections from web interface (BGAN)*
 - *Status information*
 - *The Control panel*
 - *To use the logs*
 - *Battery status information*
 - *To set up the interfaces*
 - *To manage connected devices (Traffic control)*
 - *To manage IP handsets or smartphones*
 - *Support features*
 - *Terminal settings*
 - *To set up your data connection packages (BGAN)*
 - *Multiple data connections*
 - *To set up tracking*
 - *Advanced settings*
- Optional: To set up cellular network for data*

The EXPLORER Connect app

If you are using a smartphone to configure your EXPLORER 710, you can use the EXPLORER Connect app, which is available for iPhone or iPad (from the Apple Store) and for Android phones or tablets (from Google Play).

For an overview of the functions of the EXPLORER Connect app, see [The EXPLORER Connect app for smartphones](#) on page 9.

To access the configuration settings, start the **EXPLORER Connect** app and select **Terminal Access**. From this point you have access to the same settings as from the web interface.

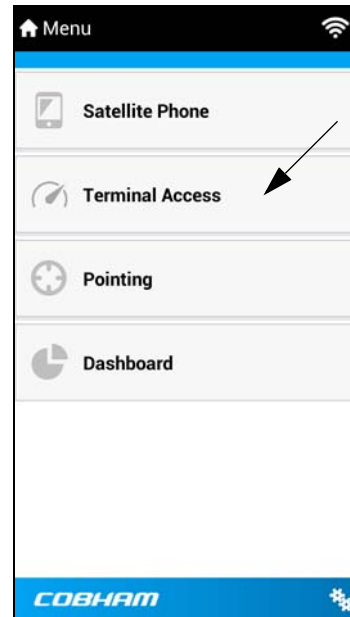

The web interface

What is the web interface?

The web interface is built into the terminal and is used for operating, setting up and configuring the system.

You can access the web interface from a computer, tablet or smartphone with a standard Internet browser.

To access and navigate the web interface

To access the web interface

To access the web interface, do as follows:

1. Start up the terminal.
For details, see [To start up the EXPLORER 710](#) on page 15.
2. Connect your computer to the terminal.
3. Open your browser and enter the IP address of the terminal in the address bar.
The default IP address of the terminal is **192.168.0.1**.

Note Some parts of the web interface may not be accessible if the user permissions are limited. For information on how to set up user permissions, see [To set up user permissions](#) on page 81.

To change the language

When you have access to the web interface, if you want to display a different language than English, do as follows:

1. Select the Control panel  in the bottom right corner.
2. Select **Terminal settings**.
3. At **Language**, select a language from the drop-down list and click **Save**.

You can change the language to **French, German, Russian, Spanish, Chinese** or **Japanese**.

Overview of the web interface

When the web interface opens, the title bar shows the name of the product. The example below shows the Terminal settings page.

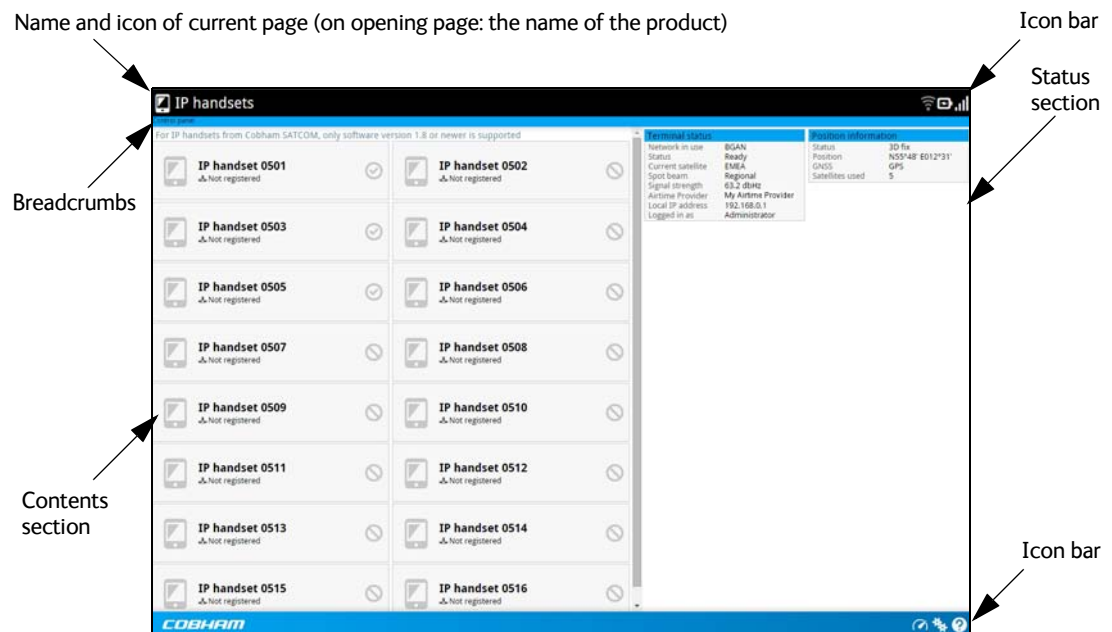















The web interface consists of the following sections.

- **Name** of current page. Tap or click to refresh the page.
- **Icon bars** at the top and bottom are present on all pages and hold icons that give access to status such as battery level and signal level as well as active alerts, when relevant. It also holds the icon for the Control panel. For explanations of the icons, see the next section, [Icons in the icon bars](#).
- **Breadcrumbs** right below the icon bar show the current location in the menu system and gives access to the higher levels in the menu.
- **Contents section** shows the contents of the selected page. This section is used for viewing or changing settings, or for performing actions. On the opening page, this section is used to start and stop data connections.

- **Status section** shows the status of the terminal and the network connection, position information, ongoing calls and data sessions etc. The Status section is not shown on small screens. If the screen is small (e.g. on a smartphone), you can show/hide the status by clicking  at the bottom of the page.

Icons in the icon bars

The icon bars are always available at the top and bottom of the web interface. Some of the icons are permanent while others are temporary.

Icon	Explanation
	Power status. The icon changes according to status. Click to see detailed battery status.
	Battery level
	Battery charging
	No battery. Running on external power.
	Signal level of the external network (BGAN or cellular). If EXPLORER Cellular Modem is connected, click to select the network to use (BGAN or EXPLORER Cellular Modem).
	An M at the signal bars shows that cellular network is active with the shown signal level.
	WLAN interface. Bright when WLAN is enabled, greyed when it is disabled. Click to access WLAN settings.
	The WLAN icon shows the number of connected devices.
	Help. Click to get context-sensitive help for the current page.
	Control panel. Click to access the settings.
	Startup page where you can start and stop data connections. Click to go to the startup page.
	The "1" at the icon shows that a BGAN data connection package is running.
	Status. If the screen is not large enough to show the status field, this icon appears at the bottom of the page. Click the icon to see status of the terminal and satellite connection. Click again to exit the status page.
	An alert is active. Click the icon to see a list of active alerts. Note that this icon will remain in the icon bar as long as the alert is still active.

To navigate the web interface

- **To access status and settings**, tap or click the relevant icon in the icon bar or select  to access the **Control panel**. The status or settings are displayed in the contents section.
- **To see your current location and to move back through the Control Panel menu**, use the breadcrumbs just below the icon bar.
- **To scroll through longer pages**, use the scroll bar or swipe.
- **To refresh the current page**, press Ctrl+F5 (PC) or Apple+R (Apple) or Cmd+R (Apple).

To enter the SIM PIN in the web interface

Do you need a SIM PIN?

Note

You may not have to enter a SIM PIN to access the terminal. This depends on whether or not the use of a SIM PIN is enabled on your SIM card.

The administrator can enable and disable the use of a SIM PIN. For details, see [To enable or disable the use of a SIM PIN](#) on page 82.

If a smartphone, tablet or computer is connected when you start up the terminal, you can access the web interface and enter the SIM PIN here.

To enter the SIM PIN

If your SIM card requires a PIN and the PIN has not yet been entered, you must enter it before you can make calls or access the Internet. Until you have entered the PIN you cannot access the satellite network, but you can still configure your terminal.

To enter the PIN, do as follows:

1. Access the web interface.
If the terminal needs a PIN, a popup window tells you to enter PIN.
2. Type in your PIN and click **OK**.

When the correct PIN is entered, the terminal is ready for pointing. When pointing is completed and the terminal is registered on the network, you are ready to make calls or access the Internet.

To cancel the SIM PIN

If you select **Cancel** when you are asked for a PIN, you can use the web interface as normal, but you will not be able to access the BGAN network to make calls or data sessions. Only emergency calls will be possible, and only if the network allows it.

To enter the PIN later, after cancelling the first time, do as follows:

1. From the icon bar at the top, click .
The alert list opens.

2. Click **Resolve** next to **Enter PIN for BGAN**.
3. Type in your PIN and click **OK**.

To point the antenna (BGAN)

Before you can use the BGAN network, you must point the antenna in the direction of the satellite and find the best possible signal strength. For detailed information on the pointing procedure, see [To point the antenna \(BGAN\)](#) on page 16.

You can use the EXPLORER Connect app or the web interface to help you with the pointing process.

Pointing in web interface

To start the pointing procedure from the web interface, do as follows:

1. If the pointing process is not automatically started, select  (Control panel) and then **Point now**.
The signal strength is shown on the screen.
2. Turn and tilt the antenna slowly until you have obtained the highest possible signal strength.
3. Click **OK**.



The terminal will now try to register on the BGAN network.

To control data connections from web interface (BGAN)

The startup page of the web interface is used to start and stop data connections and to set up the data connections.

Note If you are using the EXPLORER Cellular Modem instead of the BGAN network, see [Optional: To set up cellular network for data](#) on page 94.

To start and stop data connections



Note The icons for starting  and stopping  connections are only displayed if the terminal is ready and registered on the BGAN network. Otherwise you cannot start data connections.

To start and stop data connections on your EXPLORER 710, do as follows:

1. In the opening page, locate the connection package you want to start.

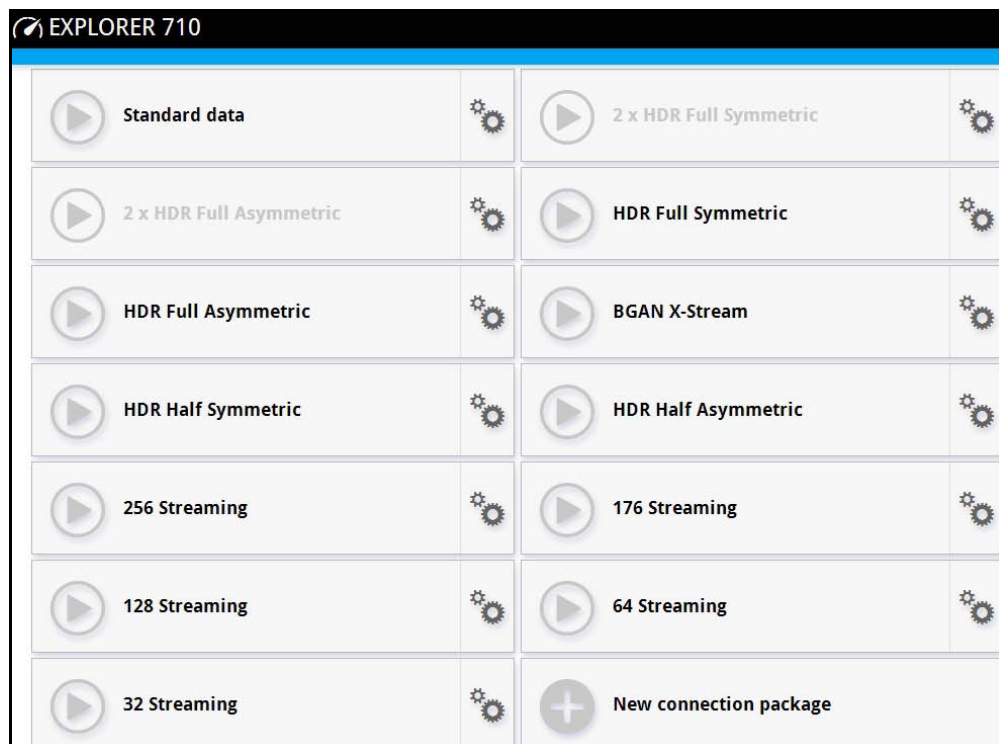
Note A connection package can consist of one or more connection types or two bonded EXPLORER 710 channels. For details, see [To set up your data connection packages \(BGAN\)](#) on page 71.



2. Click  to start the connection. If more connections are included in the connection package, this will start all included connections. The connections icon at the bottom of the page shows  when a BGAN data connection package is running.

Note Once a Streaming connection is started, the connection will run until you stop it. You will be charged for the time you are connected.

3. Click  to stop the connection.

If the connection fails, the connection tile shows an exclamation mark  and an error message. The error message is also shown in the data log, see [Data log](#) on page 52.

When a connection is active, the icon changes to  and the tile for the active connection shows:

- **IP address:** The IP address that has been assigned by the service provider to this session.
- **Transferred data:** For Standard data, the tile shows the total amount of transmitted and received data since the connection was established.
- **Connection duration:** For Streaming data, the tile shows the total time the connection has been active.
- **Bit rate:** For Streaming connections, the tile shows the fixed bit rate.
 - For the Streaming classes with a **guaranteed bit rate**, the tile shows the guaranteed bit rate.
 - For the Streaming classes with a **dynamic bit rate** (BGAN X-Stream and HDR), the tile shows the currently available bit rate. Note, however, that the bit rate is adjusted according to the traffic on the connection. It takes approximately 15 seconds for the bit rate to be updated after traffic has started on the connection.



Default data connection types

By default, the following connections are available:

Name	Type of connection
Standard data	Several users can share the data connection. This type of connection is ideal for TCP/IP traffic such as e-mail, file transfer, and Internet/intranet access. The user pays for the amount of data sent and received.
Streaming data The following Streaming classes are available: 32, 64, 128, 176 or 256 Streaming BGAN X-Stream HDR Full Symmetric HDR Half Symmetric HDR Full Asymmetric (64 kbps download, Full HDR upload) HDR Half Asymmetric (64 kbps download, Half HDR upload) 2 x HDR Full Symmetric (bonding) 2 x HDR Half Symmetric (bonding)	An exclusive, high-priority connection, ensuring seamless transfer of data. This type of connection is ideal for time critical applications like live video over IP. The user pays for the duration of the connection. “Double-channels” available when two EXPLORER 710 terminals are bonded.

You can use these connections as they are or build your own connection packages. The EXPLORER 710 also offers a bonding function, where you can connect two EXPLORER 710 terminals to double the bandwidth. For set up of the connection packages, see the section [To set up your data connection packages \(BGAN\)](#) on page 71.

Status information

If the window is large enough, it shows a status field at the bottom of the page or in the right side of the page. If not, click  at the bottom of the page to show the status page. Click  again to return to the previous page.

The Control panel

The **Control panel** is used for accessing the settings and functions of your EXPLORER 710.

To open the **Control panel**, click  from the bottom right corner of the web interface.

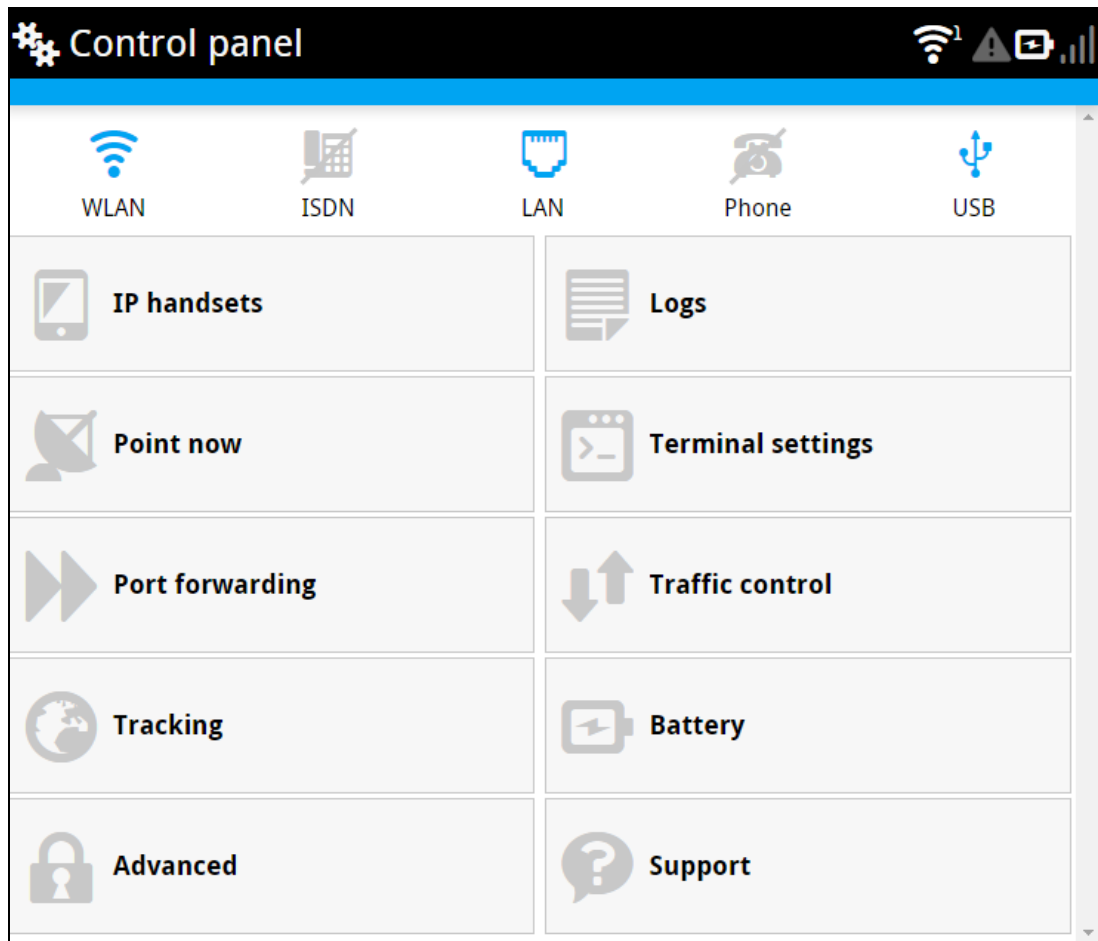

To use the logs

To access the logs

To access the Logs, select  and select **Logs** from the menu. The Logs page contains:

- **Call log:** A list of all incoming, outgoing and missed calls since the log was last cleared.
- **Data log:** A list of all data sessions since the log was last cleared.
- **Total counters:** Totals for each type of service since the log was last cleared.

Date and time is the international UTC time, received from the satellite.

Call log

The Call log shows:

- **Outgoing calls** shows the start time, receiving end phone number, duration, type (Standard voice or 3.1 kHz audio) and, if Call charges have been entered, estimated charge of each outgoing call.
- **Received calls** shows the start time, calling phone number, duration and type (Standard voice or 3.1 kHz audio) of each incoming call.
- **Missed calls** shows the start time, calling phone number and type (Standard voice or 3.1 kHz audio) of each incoming call that was not received.

The Call log also shows the termination cause of each call.

You can clear the Call log under **Control Panel**  > **Advanced** > **Clear logs** (requires Administrator password).

Data log

The Data log shows:

- **Standard data** shows data usage (bytes), date and time and estimated charge of each Standard data session (if Call charges have been entered).
- **Streaming data** shows the duration and type (such as 64 kbps, 128 kbps), date and time and estimated charge of each Streaming data session (if Call charges have been entered).

The Data log also shows the termination cause of each data session.

You can clear the Data log under **Control Panel**  > **Advanced** > **Clear logs** (requires Administrator password).

Total counters

The total counters show:

- **Call session totals** shows the total duration (hh:mm:ss) for each call type since the log was last cleared. It also shows the estimated call charge for each call type (if Call charges have been entered).
- **Data session totals** shows totals for each data connection type since the log was last cleared. For Standard data the totals are shown as amount of data transferred (kB) and for Streaming connections the totals are shown in duration (hh:mm:ss). It also shows the estimated charge for each data type (if Call charges have been entered).

You can clear the Total counters under  (Control Panel) > **Advanced** > **Clear total counters** (requires Administrator password).

Battery status information

To view the status of the internal and external (if any) battery, do one of the following:

- Click the battery symbol from the icon bar at the top of the page, or
- from the **Control panel** , select **Battery**.

The Battery page shows the **charging status** (Charging or Not charging), the **charge level** in percent and the **estimated remaining usage time**.

Note

The estimated remaining usage time can vary significantly, depending on usage. The remaining time will be shorter if the terminal is used a heavily (more interfaces in use and more calls and data sessions active).

For more information on the EXPLORER 710 batteries, see



- [To insert the battery](#) on page 11
- [Normal use of the battery](#) on page 99
- [To recharge batteries](#) on page 99
- [To connect an extra, external EXPLORER 710 battery](#) on page 100
- [Accurate display of the battery capacity](#) on page 100

To set up the interfaces

LAN interface setup

The terminal has two LAN connectors. LAN#1 is with PoE (Power over Ethernet).



To configure the LAN interface, do as follows:

1. In the **Control panel** , click the **LAN** icon  at the top of the page.
2. To enable the LAN interface, select **Enable**.

Note | It may take some seconds to enable the interface.

3. To enable Power over Ethernet (PoE) on LAN#1, select **Enable** next to **Power over Ethernet**.

PoE is used e.g. for powering IP handsets. If you are not using PoE, you can save power by disabling PoE.



4. Click **Save**.
 -  A line through a greyed-out **LAN** icon means the interface is **disabled**.
 -  A blue **LAN** icon means the interface is **enabled**.

For a description of how to set up the **LAN network parameters**, see [To set up the connection mode](#) on page 66.

WLAN interface setup

Note | The Internet settings entered in the Terminal settings page also apply for the WLAN interface. See [Internet and LAN connection modes](#) on page 67.

To configure the WLAN interface, do as follows:

1. In the **Control panel** , click the **WLAN** icon  at the top of the page.
2. To enable the WLAN interface, select **Enable**.



Note | It may take some seconds to enable the interface.

3. Next to **Region**, select the region you are located in.

Note | In some countries, the use of WLAN is not allowed. Before continuing, make sure WLAN is allowed and licensed in the country where you intend to use it.

4. Select the **Channel** number used for communication on the WLAN interface.
5. Select **Broadcast SSID** to show your WLAN access point to other users.
If you **clear** the box, your WLAN access point is hidden.
6. Type in the **SSID**.

The SSID is a max. 32 character text identifying the wireless local area network. All wireless devices on a WLAN must use the same SSID in order to communicate with each other. The default SSID is **EXPLORER710**.

7. Select the **Security** standard. You may select one of the following encryption standards:
 - None (no encryption is applied)
 - WEP-40/64
 - WEP-104/128
 - WPA-TKIP
 - WPA2-AES (selected by default)
8. Next to **Key type**, select **Hexadecimal** or **Text**.
The encryption key must normally be a hexadecimal code. However, if you are using WPA-TKIP or WPA2-AES encryption (default) you can choose to use a text string, which may be easier to memorize.
9. Type in the **Encryption key** for the selected Security standard (not applicable if security mode = None). The default encryption key is the **serial number** of the EXPLORER 710. You can find the serial number under **Control panel > Support > About** or on the label on the EXPLORER 710.
10. Click **Save**.
 -  A line through a greyed-out **WLAN** icon means the interface is **disabled**.
 -  A blue **WLAN** icon means the interface is **enabled**.

Port forwarding

Note | Make the port forwarding configuration before starting the data session.

Port forwarding enables you to set up a server connected to the terminal while the terminal is in Router mode. Without port forwarding it would not be possible to contact the server from the Internet. We recommend using a static public IP address for the terminal in order to provide easy access to the terminal. To use the static IP address, it must be included in your subscription and you must set the APN source to SIM default. For details, see [To change the APN for a connection package](#) on page 72.

The following example shows how to allow Internet access to a mail server (smtp) connected to the terminal.

The mail server in this example has the IP address 192.168.0.100.



1. From the **Control panel** , select **Port forwarding**.
2. Select **Forward port** to add a new port forwarding.
3. Select **Active** to activate the port forwarding.
4. Type in the **Incoming port start** and the **Incoming port end**.
This is the range of port numbers on the EXPLORER 710 for which incoming traffic to the EXPLORER 710 will be forwarded.

5. Type in the **Destination IP** address, which in this example is the IP address of the mail server: 192.168.0.100.
This is the IP address to which the incoming traffic is forwarded.
6. Type in the **Destination port start** and the **Destination port end**.
This is the range of port numbers, in this example on the mail server, to which the incoming traffic will be forwarded.
7. Click **Save**.



When you have activated a data connection, you can now access the mail server from the Internet, using the external IP address of the terminal. You can see the external IP address in the tile with the data connection you have started. For information on how to activate your data connection, see [To start and stop data connections](#) on page 49.

Phone interface setup

To configure the Phone interface, do as follows:



1. In the **Control panel** , click the **Phone** icon  at the top of the page.
2. To enable the Phone interface, select **Enable**.

Note | It may take some seconds to enable the interface.



3. Set the call type for incoming calls.
You can select **Standard voice** or **3.1 kHz audio** or both.
 - If you select both, any device connected to the Phone interface will react (ring) on incoming calls.
 - If you select e.g. Standard voice, the Phone interface will only react on calls made to the Standard voice phone number.
4. Select the **Preferred outgoing call type**.
The selected type will be used by default, if possible, for any outgoing call.
5. Click **Save**.
 -  A line through a greyed-out **Phone** icon means the interface is **disabled**.
 -  A blue **Phone** icon means the interface is **enabled**.

ISDN interface setup

To configure the ISDN interface, do as follows:

1. In the **Control panel** , click the **ISDN** icon  at the top of the page.
2. Click the ISDN number you want to change settings for.
3. To enable the ISDN interface, select **Enable (all ISDN devices)**.



Note | It may take some seconds to enable the interface.

4. Set the call type for incoming calls.
You can select **Standard voice**, **3.1 kHz audio**, **UDI** and/or **RDI**.
An incoming call to the ISDN interface will only make the connected device ring if the call type used for the call is selected here.
5. Click **Save**.
 -  A line through a greyed-out **ISDN** icon means the interface is **disabled**.
 -  A blue **ISDN** icon means the interface is **enabled**.



USB interface setup

Note that the USB interface is a Host interface, primarily used for charging devices such as tablets or smartphones and for recovery software upload.

To configure the USB interface, do as follows:

1. In the **Control panel** , click the **USB** icon  at the top of the page.
2. To enable the USB interface, select **Enable**.

Note | It may take some seconds to enable the interface.

3. Select the **Charge current**.
Select **0.5 A** or **2.0 A**, depending on the specifications for the device you are going to connect.
4. Click **Save**.
 -  A line through a greyed-out **USB** icon means the interface is **disabled**.
 -  A blue **USB** icon means the interface is **enabled**.

To manage connected devices (Traffic control)

By default, traffic control is disabled, which means that all traffic is allowed.

With the Traffic control function you can get an overview of devices connected to your EXPLORER 710 and control which devices you want to connect. You can also select whether or not they should be allowed to use BGAN or cellular network. Note that the available settings depend on whether or not you are logged in as administrator.

Note

The cellular modem setting is only available if an EXPLORER Cellular Modem is inserted in the EXPLORER 710.

Traffic control (Non-administrator user)

To set up traffic control, do as follows:

1. In the **Control panel** , click **Traffic control**.
A list of connected and added devices appears.

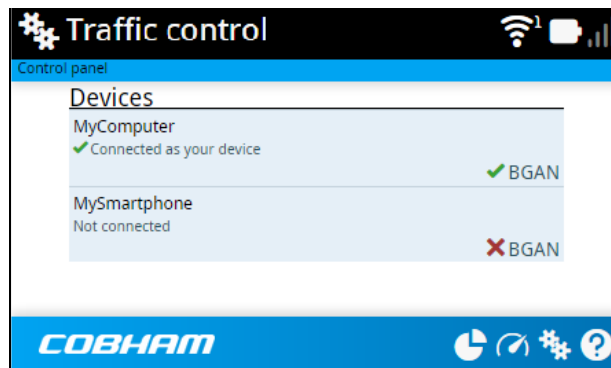

2. Click your connected device to see MAC address and IP address and to change the name or block/allow the use of BGAN or Cellular network. See the next section.

To block BGAN or cellular traffic or edit the name for your device

Note

You can only change these settings if traffic control is enabled. If the administrator has disabled traffic control, all traffic is allowed.

1. In the **Traffic control** page, click your connected device.
The page shows the name, MAC address, IP address and traffic rule for the device.
2. Select **Block BGAN traffic** or **Block Cellular traffic** (if available), if you want to deny access to BGAN or cellular network for your device.

Note

If it is already blocked by the administrator, this setting is not editable.

3. At Name, type in the name you want for your device.
4. Click **Save**.

Traffic control (Administrator)

When you are logged in as administrator (or administrator password is disabled), the Traffic control setup offers more options. To set up traffic control as administrator, do as follows:

1. Log in as administrator (or make sure administrator password is disabled).
2. In the **Control panel** , click **Traffic control**.
A list of connected and added devices appears.
3. Click the **Enable** button to enable Traffic control.
By default Traffic control is disabled, which means all devices are allowed access.

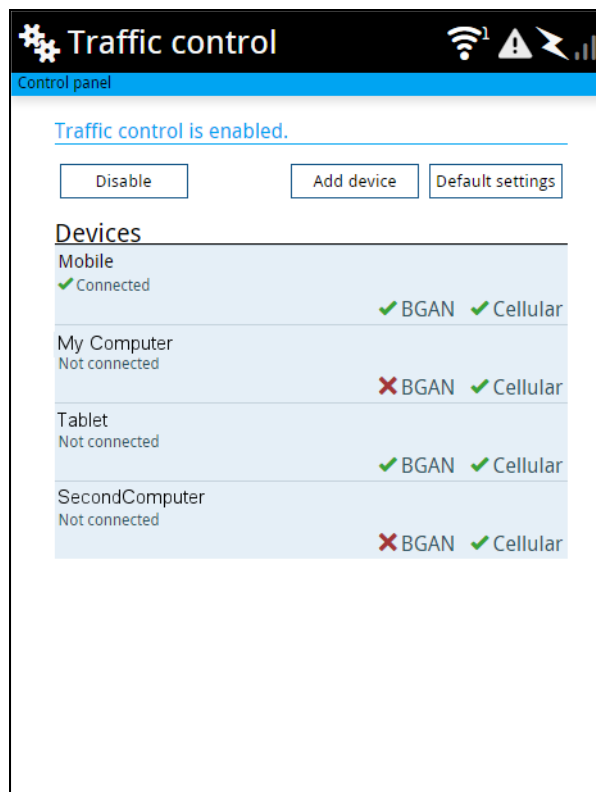

To change the default settings for all devices

Important

All devices in the list are updated with the default settings when you click Save.

1. Click the button **Default settings**.
2. Select **Block BGAN traffic** or **Block Cellular traffic** (if available) if you want to deny access to BGAN or cellular network for all devices. With this option selected, only the administrator will be able to allow access for selected or all devices.
3. Click **Save**.
All devices in the list will now have the default settings.

To block or allow BGAN or cellular traffic or edit the name for a device

1. In the **Traffic control** page, click the device you want to set up.
The page shows the name, MAC address, IP address and traffic rule for the device.
2. Select **Block BGAN traffic** or **Block Cellular traffic**, if you want to deny access to BGAN or cellular network for the selected device.
If you want to allow access, clear the box. The selected device will then be able to access the network, even if it is blocked in the default settings (see previous section).
3. At **Name**, type in the name you want for your device.
4. Click **Save**.

Reset to default:

You can reset the settings for the device to the default settings (see previous section).

- If the device is connected and you click the button **Reset to default**, the traffic rules will be reset to the default values set in [To change the default settings for all devices](#) on page 59, but the name remains the same.
- If the device is **not** connected and you click the button **Reset to default**, the device is removed from the list.

To Add a device

When you connect a device, it is automatically added to the list using the default settings. If you want to add a device for later use, do as follows:

1. In the **Devices** page, click the **Add device** button.
2. Type in the **Name** and the **MAC address** for the device.
3. Select **Block BGAN traffic** or **Block Cellular traffic**, if you want to deny access to BGAN or cellular network for the selected device.
If you want to allow access, clear the box. The selected device will then be able to access the network, even if it is blocked in the default settings (see previous section).
4. Click **Save**.

When the device with this MAC address is connected, it will appear with the entered name in the list, and access will be allowed or denied depending on the setting in this page.

To manage IP handsets or smartphones

Overview

This section describes how to manage smartphones and IP handsets connected to the EXPLORER 710.

The terminal supports connection of up to 16 phones through the LAN WLAN interface. Each phone must have a local number in the range 0501 to 0516 as well as a unique password. For details, see the next section.



For details on SIP settings and how to connect your phone to the LAN or WLAN interface, see [To connect a phone using LAN or WLAN](#) on page 21.

To manage IP handsets or smartphones in your EXPLORER 710

Do as follows:

1. Connect your smartphone to the WLAN interface of the terminal or your IP handset to the LAN#1 interface. For details, see [To connect a phone using LAN or WLAN](#) on page 21.
2. In the web interface, select  (Control panel) > **IP handsets**.
3. Click the tile for the handset number you want to manage.
4. Select **Enable** to enable the handset.

Note | It may take some seconds to enable the handset.

-  on the tile for your handset means the handset is **disabled**.
 -  on the tile for your handset means the handset is **enabled**.
5. To change the **Password**, simply type in the new number.
 6. Set the call type for incoming calls.
You can select **Standard voice** or **3.1 kHz audio** or both.
 - If you select both, the handset will react (ring) on incoming calls.
 - If you select e.g. Standard voice, the handset will only react on calls made to the Standard voice phone number.
 7. Select the **Preferred outgoing call type**.
The selected type will be used by default, if possible, for any outgoing call from this handset.
 8. Click **Save**.
 9. In the smartphone or IP handset, enter the local number and the password you just entered in the EXPLORER 710. See the documentation for your handset for details.

Note | The user name is also the local number for the handset.

The handset remains in the list after disconnecting. When the handset is connected again, it is automatically recognized and ready for use, if enabled.

Support features

To open the Support page, select  (Control panel) > **Support**.

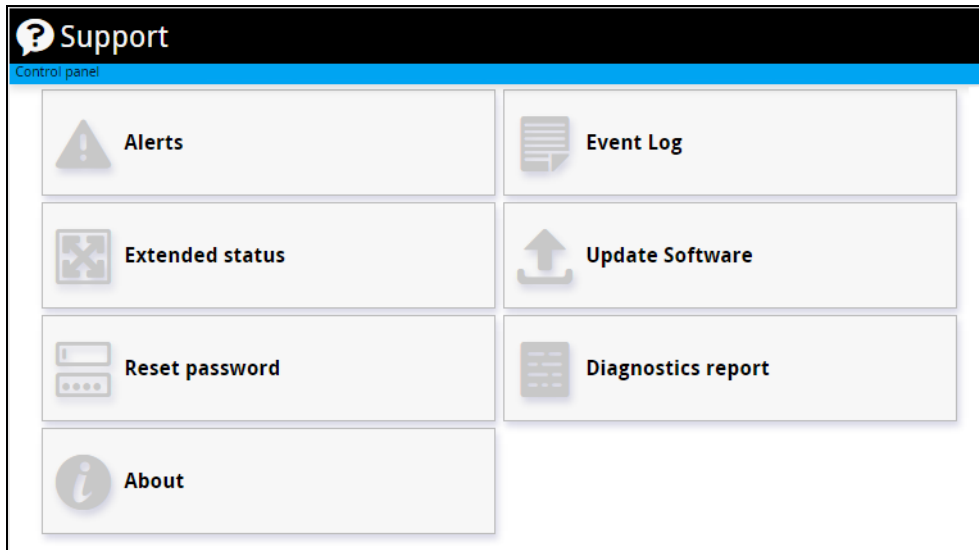

To view the Alerts

When an alert is registered, the web interface shows a warning icon  in the icon bar as long as the alert is active. The **Alerts** list only shows alerts that are currently active.

1. To view the alerts, click  from the icon bar at the top of the web interface, or select **Alerts** from the **Support** page.

The **Alerts** page shows a detailed list of active events including the time of the first occurrence, ID and severity of the event message, and a short text describing the error. For more information on the event messages, refer to [List of messages](#) on page 109.

To view the Event log

The Event log shows events that occurred in the past and are no longer active. It includes events of informational character describing normal phases of operation for the terminal, and also alerts that have appeared in the Alerts list.

To view the event log, select **Event log** from the **Support** page.

To create a diagnostics report

The diagnostic report contains relevant information for troubleshooting. When contacting your supplier for support, please enclose this file. To generate a diagnostic report, do as follows:

1. From the **Support** page, click **Diagnostics report**.
2. Click **Generate report**.

Note | It may take a few minutes to generate the report.

3. Select **Download report**.
4. Choose a location for the file and save it.

To update software

Important

If the battery power is 25% or less you must connect DC power to the terminal before starting the software update. Once connected, do not remove DC power until the software update is completed.

To update the software in the EXPLORER 710, do as follows:

1. Download the new software¹ or acquire the software from Cobham SATCOM and save it on your computer.
2. Open the web interface and enter the Control panel .
3. Click **Support > Update software**.
4. Click **Update software...**
5. Browse to the new software version and click **Open**. The software file has the extension ".tiff".
6. The terminal restarts and completes the software update.

Note

The update procedure takes some minutes to complete. During the software update, the Status LED is flashing blue.

You can check the software version under **Control panel > Support > About**.

If, for some reason, you cannot upload software using the web interface, you can also use the USB interface. For details, see [To update software with USB](#) on page 97.

To view extended status

To see the Extended status page, select **Support > Extended status**.

To view updated information on the **Extended status page**, click the icon in the top left corner to refresh the page.

The Extended Status page shows information such as IAI-2 status, IMSI number and IMEI number.

-
1. You can download the software from the "Self Service Centre" at www.cobham.com/communications-and-connectivity/satcom, select **Service and Support > AVIATOR, EXPLORER, SAILOR Service and Support** and then **24-7 Self Service Centre / Technical Downloads**. Locate the EXPLORER 710 software.

To reset the administrator password

If you have forgotten the administrator password, do as follows:

1. Contact your supplier for a reset code.
Report the serial number and IMEI number of the terminal.
You can find the serial number and IMEI number in the display on the terminal by selecting the menu  and then **Properties**.
2. After receiving the reset code from your supplier, select **Reset password** from the **Support** page.
3. Type in the reset code obtained from your supplier and click **Reset**.
4. The password is disabled.

You now have access to all settings. If you want to use a password, enable the password as described in [To enable the administrator password](#) on page 80.

About

The **About** page shows the **Serial number** and **software version** of your EXPLORER 710 and legal information. It also shows your **Help desk** information, if it has been entered under **Advanced > Help desk**.

To access the About page, select **Support > About**.

Terminal settings

To configure the terminal settings, select  (Control panel) > **Terminal settings**.

Terminal settings

Control panel

Enter new values and click Save

Power up

Power-up mode when using external power

Pointing mode at start-up

Connection

Startup mode

Use Router mode when connecting more than one device to the terminal.

Internet connection mode

Local IP address

Automatic activation of Standard data

DHCP

DHCP can only be used in Router mode.

DHCP Enabled

Network mask

DHCP range start

DHCP range end

Channel bonding

Enable

Bonding server

Bonding server user name

Bonding server password

Audio indication

Audio assisted pointing

GNSS

GNSS type

Language

Select language

COBHAM

Power-up mode with external power

You can set the terminal to automatically power up when external power is applied.

1. In the **Terminal settings** page, locate **Power-up mode when using external power**.
2. Select **Automatic** or **Manual**.
 - Automatic means the terminal powers up automatically when external power is applied.
 - Manual means you must use the power switch to power the terminal.
3. Click **Save**.

Pointing at start-up

You can set up the EXPLORER 710 to automatically register on the BGAN network at start-up. This is useful e.g. for semi-fixed or fixed installation, where the EXPLORER 710 is not moved around between start-ups. See [Fixed antenna installation](#) on page 28.

1. In the **Terminal settings** page, locate **Pointing mode at start-up**.
2. Select **Automatic** or **Manual**.
 - If the EXPLORER 710 is moved around between each power up, select **Manual** from the drop-down list. With this setting, the terminal will go through the pointing procedure every time the terminal is powered.
 - If the EXPLORER 710 antenna is placed in a fixed position and the signal strength is sufficient, select **Automatic** to make the EXPLORER 710 automatically register on the satellite network when the terminal is powered.
3. Click **Save**.

To set up the connection mode

Startup mode (select network)

The EXPLORER 710 can use a cellular network as an alternative to the BGAN network. For details, see [Optional: To set up cellular network for data](#) on page 94.

To set up which network you want to use when starting up the EXPLORER 710, do as follows:

1. In the **Terminal settings** page, locate **Connection**.
2. At **Startup mode**, select from the drop-down list which mode you want the EXPLORER 710 to start up in. You have the following options:
 - **BGAN** (default): The EXPLORER 710 uses BGAN. If you connect an EXPLORER Cellular Modem, you can select that instead, but BGAN will always be used at startup.
 - **Cellular**: The EXPLORER 710 only uses the cellular network, not BGAN. If an EXPLORER Cellular Modem is not connected, or if the cellular network does not work for some reason, you cannot access any network.

- **Cellular modem if available:** The EXPLORER 710 uses cellular network if it is available at startup (that is if the EXPLORER Cellular Modem is inserted and the cellular network is found)
- **User selection:** Every time the EXPLORER 710 starts up you must select which network you want to use. You cannot access any network until you have made the selection.

Internet and LAN connection modes

In the web interface you can set up the Internet connection mode and the IP addressing between the EXPLORER 710 and devices connected to the EXPLORER 710. The EXPLORER 710 has a built-in DHCP server which can be used to dynamically assign IP addresses to devices connected to the EXPLORER 710.

The drawing below shows examples of the IP addressing in router mode (default setup) and modem mode.

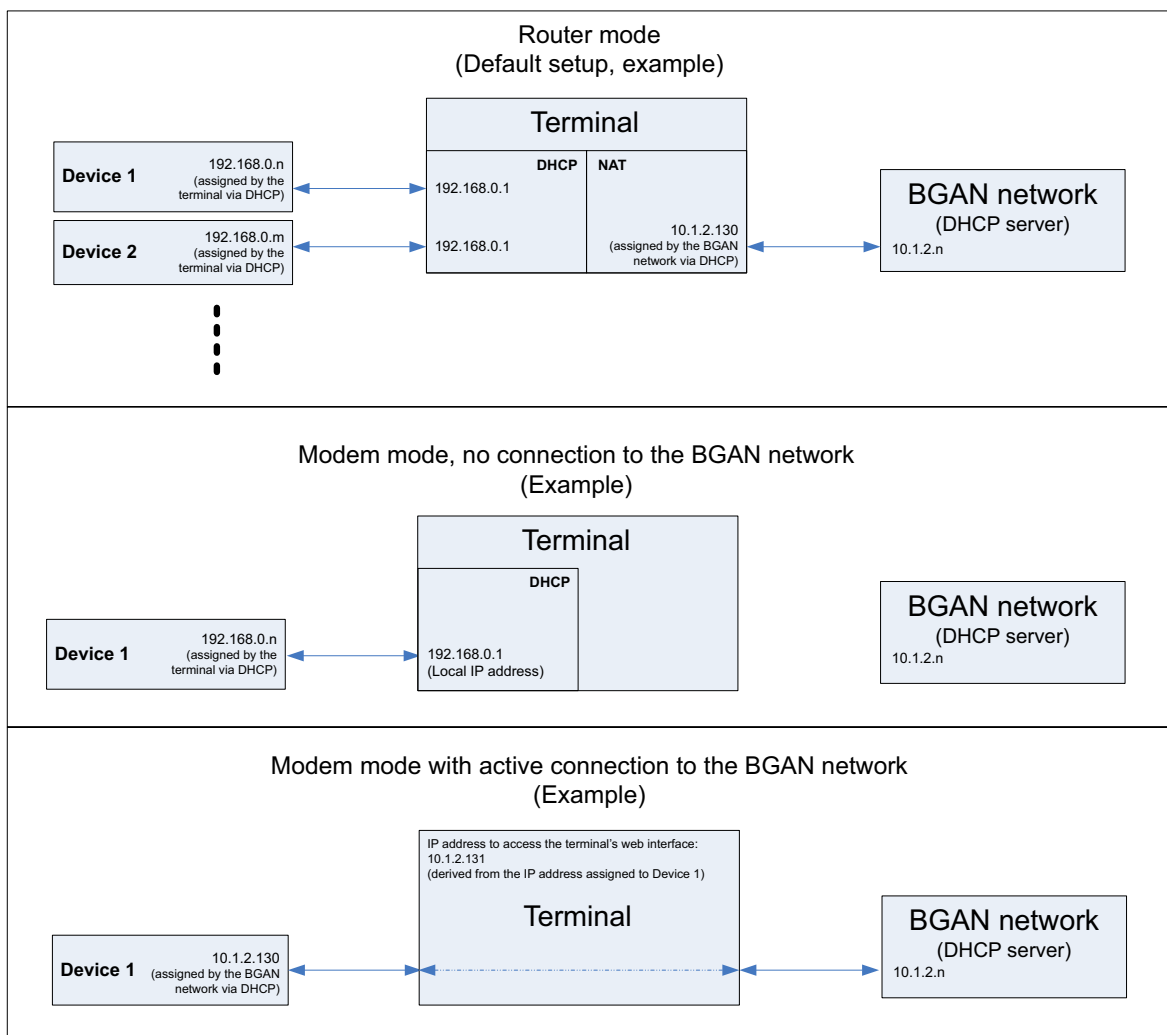

To set up the connection mode of the EXPLORER 710, do as follows:

1. From the **Terminal settings** page, locate **Connection**.

2. At **Internet connection mode**, select **Modem mode** or **Router mode**. Router mode is the default setting and is recommended for most purposes.
 - Select **Router mode** if one or more computers are connected and the EXPLORER 710 should act as a router. When Router mode is selected, the EXPLORER 710 uses the built-in NAT module for making the necessary address translations.
 - Select **Modem mode** if only one computer is connected, and the EXPLORER 710 should act as a modem, or more than one computer is connected using an external router.¹

Note Do **not** connect more than one computer in Modem mode, unless you have an external router.

3. Under **Local IP address**, type in a new IP address if you want to change the Local IP address of the terminal. This is the address used to access the web interface. The default IP address is **192.168.0.1**.

Important Do **not** use the IP address 192.168.1.1. It is reserved for internal use.

Note If the EXPLORER 710 is in modem mode and connected to the BGAN network (see previous step), you **cannot use this address to access the web interface**, because the network dynamically assigns the IP address for the EXPLORER 710.

So to access the web interface in modem mode, you must do one of the following:

- Access the web interface when there is no data connection on the BGAN network
- Check the IP address of your connected equipment and add 1 to the last number. This is the IP address to access the web interface. (See the drawing in the previous page).

4. To enable automatic activation of your data connection, select **Automatic activation**.
 - When you **select** automatic activation and connect to the LAN or WLAN interface, the data connection is automatically established as soon as the EXPLORER 710 and its BGAN connection are ready.

Note You are charged for the data transferred. You may want to disable automatic updates in your LAN or WLAN device to avoid unnecessary charges.

- When you **disable** automatic activation (default), you can control the data connection manually from the startup page (🔧).
5. Under **DHCP**, select **DHCP Enabled** (recommended for most purposes).
 - If you select **DHCP Enabled**, the terminal assigns dynamic IP addresses to devices connected to the terminal.

-
1. Note that in modem mode the local IP address is assigned by the external network (see drawing in the beginning of this section), so when the terminal is connected to the external network you **cannot access the web interface** with the usual local IP address. When the external network is disconnected, the local IP address falls back to the address mentioned in step 3. (next step).

- If **disable DHCP**, you need to set up a static IP address in the connected device.
6. If you want to change the **Network mask** for the local network of the terminal, type in the new network mask. The default network mask is **255.255.255.0**.
 7. Under **DHCP range start** and **DHCP range end**, type in the range of IP addresses that should be assigned to locally connected equipment.
 8. Click **Save**.

To set up channel bonding

You can connect two EXPLORER 710 terminals to obtain a higher bandwidth. First set up each of the two terminals as described below.

Note

A bonding server must first be set up, in order receive and “reassemble” the two signals into one at the receiving end. You must know the server name, user name and password in order to set up the EXPLORER 710 terminals used for bonding.

You find the Bonding server application in the Cobham SATCOM Self Service Center at www.cobham.com/communications-and-connectivity/satcom, select **Service and Support > AVIATOR, EXPLORER, SAILOR Service and Support** and then **24-7 Self Service Centre / Technical Downloads**.

1. In the **Terminal settings** page, locate the **Channel bonding** section.

Channel bonding	
Enable	<input checked="" type="checkbox"/>
Bonding server	<input type="text" value="10.0.0.1"/>
Bonding server username	<input type="text" value="My User Name"/>
Bonding server password	<input type="text" value="My Password"/>

2. Select **Enable** to enable channel bonding.
3. At **Bonding server**, enter the name of the server used for the bonding function. You can type either the name or the IP address of the server.
4. Enter the user name and password for the server.
5. Click **Save**.
6. Connect and start up the two EXPLORER 710 terminals as described in [Bonding of terminals](#) on page 32.

To enable or disable the pointing sound

The EXPLORER 710 can make a sound to guide you through the pointing procedure (default enabled). To enable or disable the pointing sound, do as follows:

1. In the **Terminal settings** page, locate the **Audio indication** section.

2. Select **Audio assisted pointing** if you want to use a pointing sound to assist your pointing process.
3. Click **Save**.

To select the GNSS type

To select which navigation system to use with your EXPLORER 710, do as follows:

1. In the **Terminal settings** page, locate the GNSS section.
2. Select **GPS, GLONASS, GPS and GLONASS** or **BeiDou-1**.
3. Click **Save**.

Note | It may take some minutes for the EXPLORER 710 to change the navigation system.

To select the language

The default language of the web interface is **English**. You can change the language to **French, German, Russian, Spanish, Chinese** or **Japanese**.

To change the language, do as follows:

1. In the **Terminal settings** page, locate the **Language** section.
2. Select a language from the list and click **Save**.

To set up your data connection packages (BGAN)

Connection packages

If you want to be able to	Do as follows
Run one connection at a time from the startup page.	This is the default setup, with only one connection in each connection package. Start the connection you need from the web interface or the display.
Use different connection types for different types of traffic.	Add more connections to a connection package and apply filters to assign different connection types to different types of traffic. See To create a package with multiple connections below. Start all the connections in the package by starting the package from the web interface or the display.
Extend your bandwidth by connecting two EXPLORER 710 terminals (bonding).	Set up two EXPLORER 710 terminals as described in To set up channel bonding on page 69 and Bonding of terminals on page 32. Start the bonding connection package from the web interface or the display (typically named 2 * <connection type>).

To change the contents of a connection package

To change the contents of a connection package, click  in the right side of the tile with the connection package that you want to change.

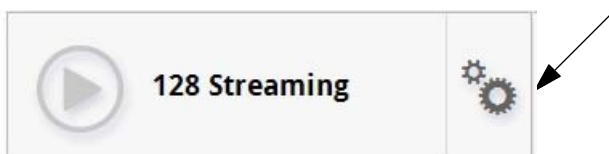

If you want to	Do as follows
Change the name of the connection package	Click Properties , type in the new name and click Save . The new name is shown on the tile on the startup page.
Delete a connection package	Click Delete package ^a Note: You cannot delete Standard data .
Remove connections from the connection package	Click  in the tile with the connection you want to remove.
Add a connection to the package	See Multiple data connections on page 73.

a. If you accidentally delete a connection package, you can either create a new manually, or restore factory settings. Note, however, that all changes to the configuration will be lost if you restore factory settings.

To change the APN for a connection package

By default a connection package is set to use no IP Header compression and to use the APN (Access Point Name) from the SIM card. This is suitable for most applications.

Note

It is recommended to leave **IP Header compression** disabled. This means that the data packets are transmitted more reliably with less data loss. However, you can select IP Header compression with the risk of less stability.

If you want to use a different APN, do as follows:

1. Click  in the right side of the tile with the connection package that you want to change.
2. Select **Parameters**.
3. Next to **APN**, select the source of the APN.
 - **SIM default** (default and recommended setting): The APN is taken from the SIM card.
 - **Network assigned**: The APN is assigned from the network.
 - **User defined**: APNs are provided from the Airtime Provider. Type in the APN next to **User defined name**.
4. If your APN uses a password, type in the **User name** and **Password** provided from the Airtime Provider.
5. Click **Save**.

Multiple data connections

If you want to have different types of connections running at the same time, you can build connection packages with the connections you want, using filters to determine which traffic should use which connection type.

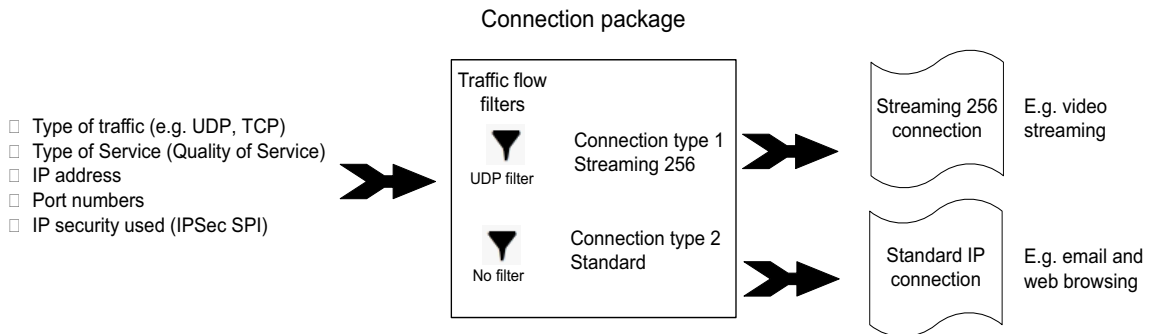

You then have to set up the following:

- Create a new package. See the next section [To create a package with multiple connections](#).
- Add connections to the package and select a predefined filter for each connection.
- Optional: Change the APN for the package. See [To change the APN for a connection package](#) on page 72.

Example: You want to be able to send email while making a live video transmission with your EXPLORER 710:

You build a new package containing 2 connections:

1: A 256 kbps streaming connection (for your video transmission). Select the UDP filter.

2: A Standard connection (for email etc.). Select "No filter".

When you have started this connection package, your video input to the EXPLORER 710 terminal is now automatically routed to the 256 kbps streaming connection. All other traffic is routed to the Standard data connection.

To create a package with multiple connections

1. From the startup page, click **New connection package**.



2. Type a name for the new connection package and click **Save**.

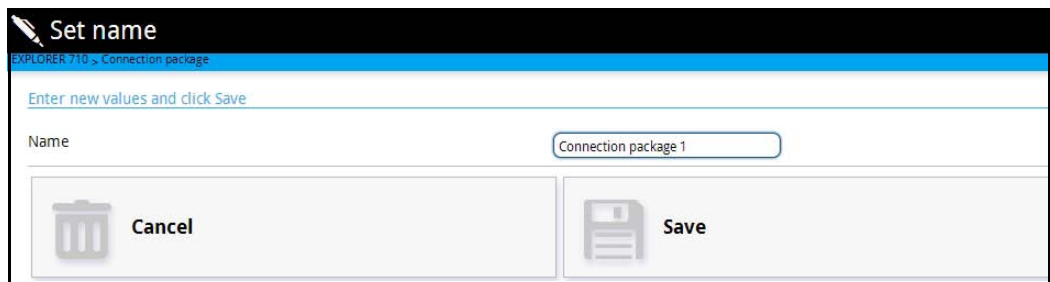

3. Click **Click here to create connections**.

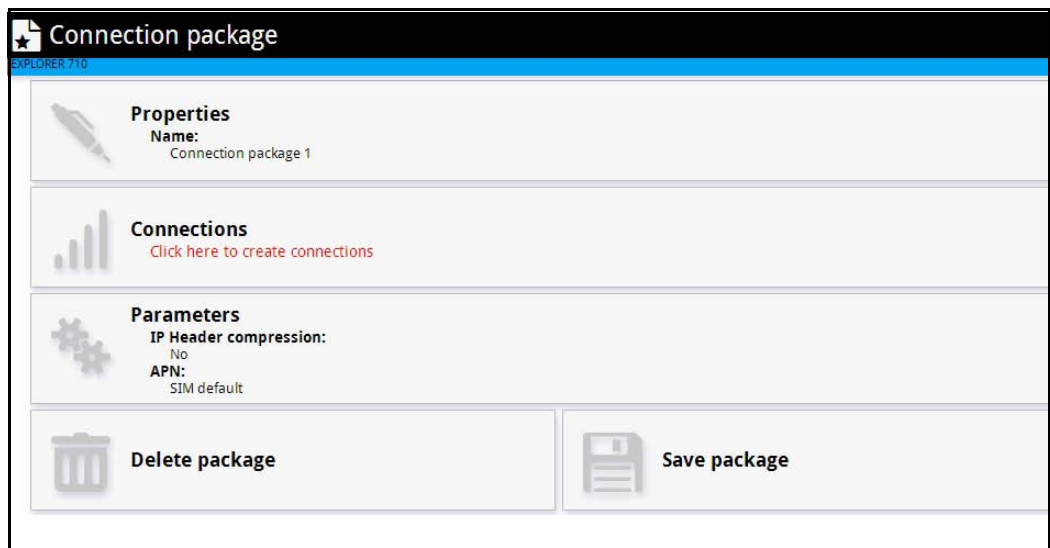

4. To add a connection to the connection package, click **Add connection** and select the type of connection you want to add.

Important

The filters are applied in the order they are added. This means that if you want to have a connection with no filter, it must be the last connection you add to your connection package. If not, the next filters are ignored, because “No filter” means all data passes through without filtering.

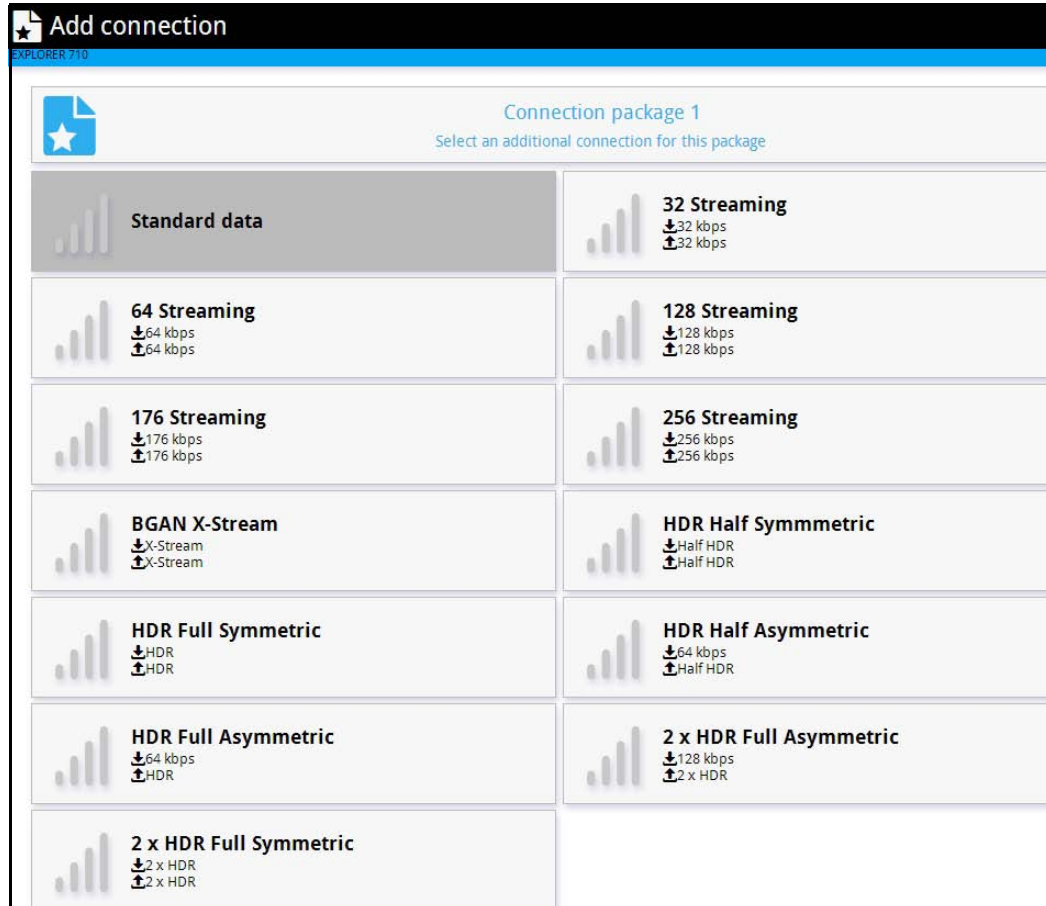

5. Select a predefined filter for your new connection.

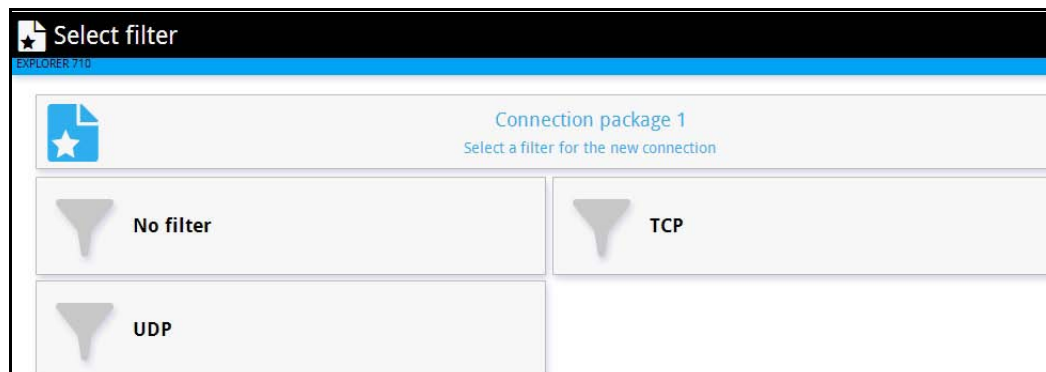

The predefined filters are:

- **UDP**: Filters traffic using UDP protocol (such as video streaming or Voice over IP).
- **TCP**: Filters Traffic using TCP protocol (such as web browsing)
- **No filter**: All data pass through. **Use only for the last connection** you add to your package.

The filters are applied in the order in which they were defined. This means that if you have a connection with no filter as the last connection, all traffic that does not match the first filters in the list will be passed through on this last connection. For this reason we recommend a Standard data connection for the “No filter” connection.

Note If you need a different filter than the ones available, you can log in as administrator and add new filters to the list. See [Traffic flow filter templates](#) on page 91.

The connection package now shows your first connection.

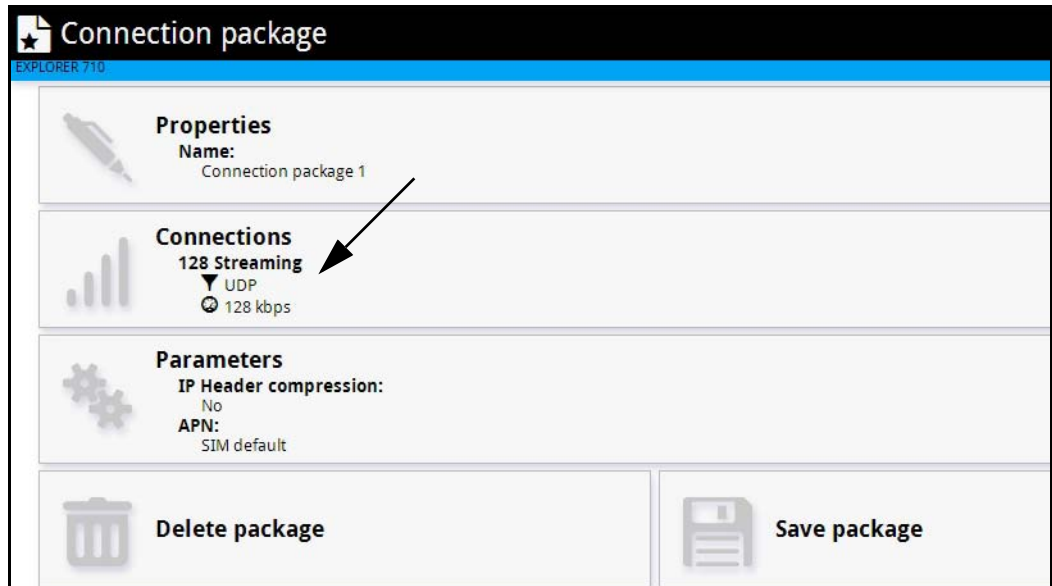

6. Click the **Connections** tile.
7. To add a second connection, click **Add connection**.
8. Select a connection type for your second connection.

Note You may not have all connection types available if you have selected a streaming type for your first connection, because your total bandwidth will be “filled up”.

9. Select a filter for the connection.
- If this is the last connection in your connection package, you may select No filter, in order to let all remaining traffic use this connection

The connection package now contains the two connection types.

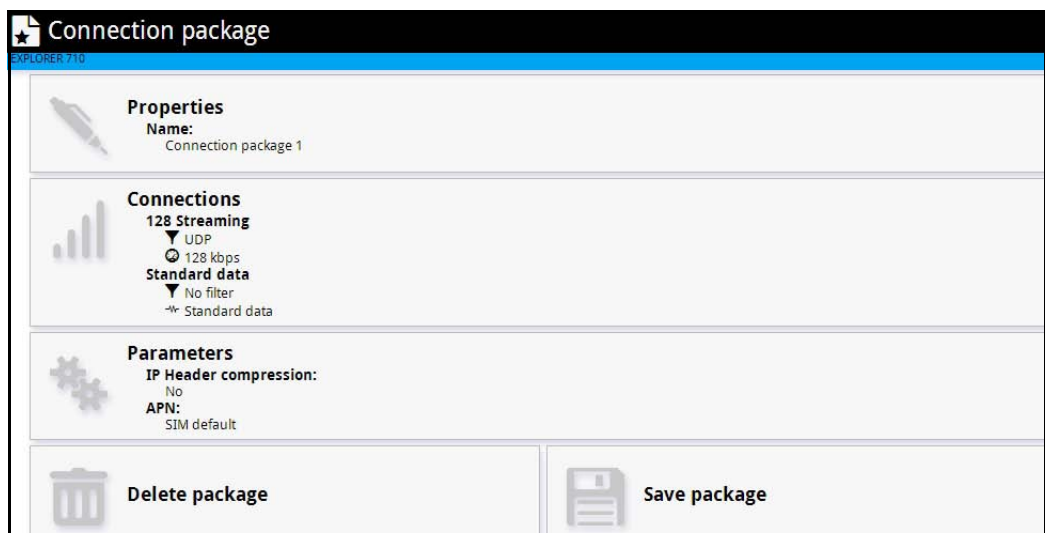

10. Click **Save package**.

The New connection package is now on the startup page.

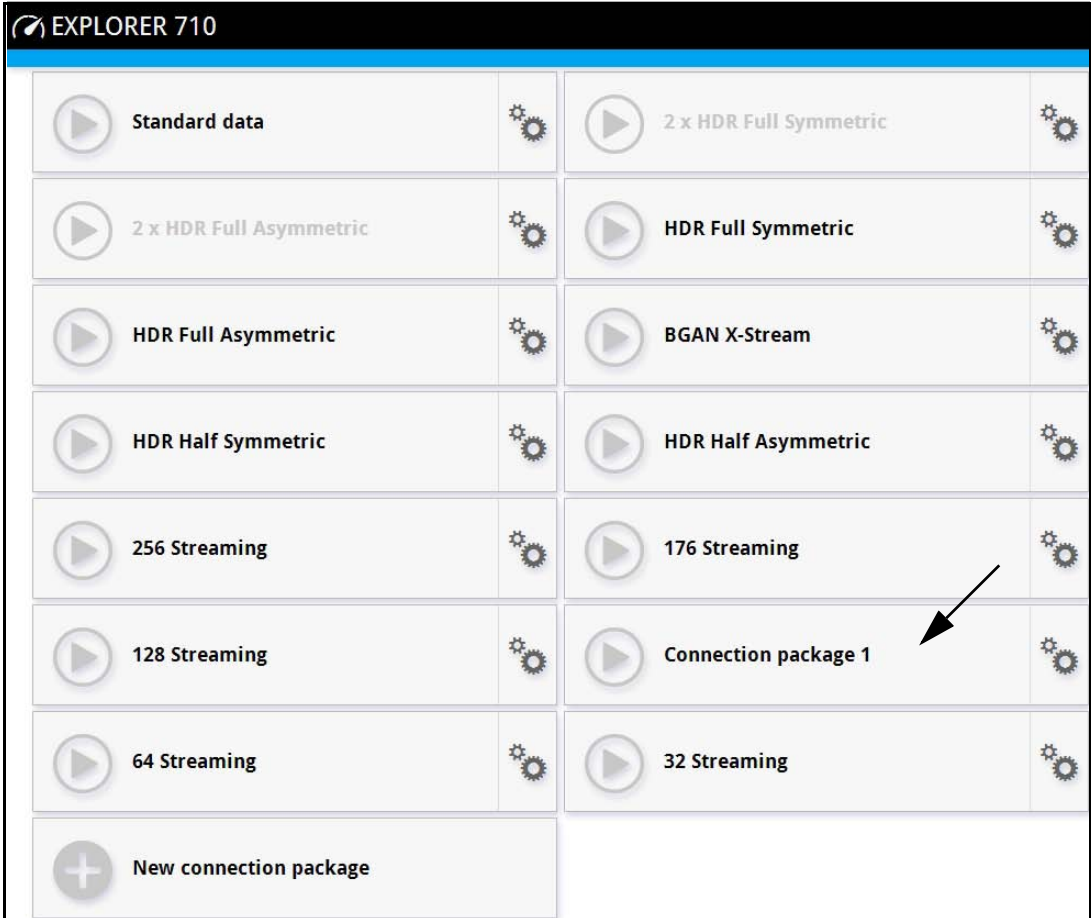

When traffic is detected on the LAN or WLAN interface, the filters are used to route the traffic. E.g. if you connect your video equipment with UDP traffic to the EXPLORER 710, your video transmission will use the connection that has UDP in the filter settings (128 Streaming in the example above).

To set up tracking

You can set up the EXPLORER 710 to report to a server at certain time intervals. To set up tracking, do as follows:

1. From the Control panel , select **Tracking**.

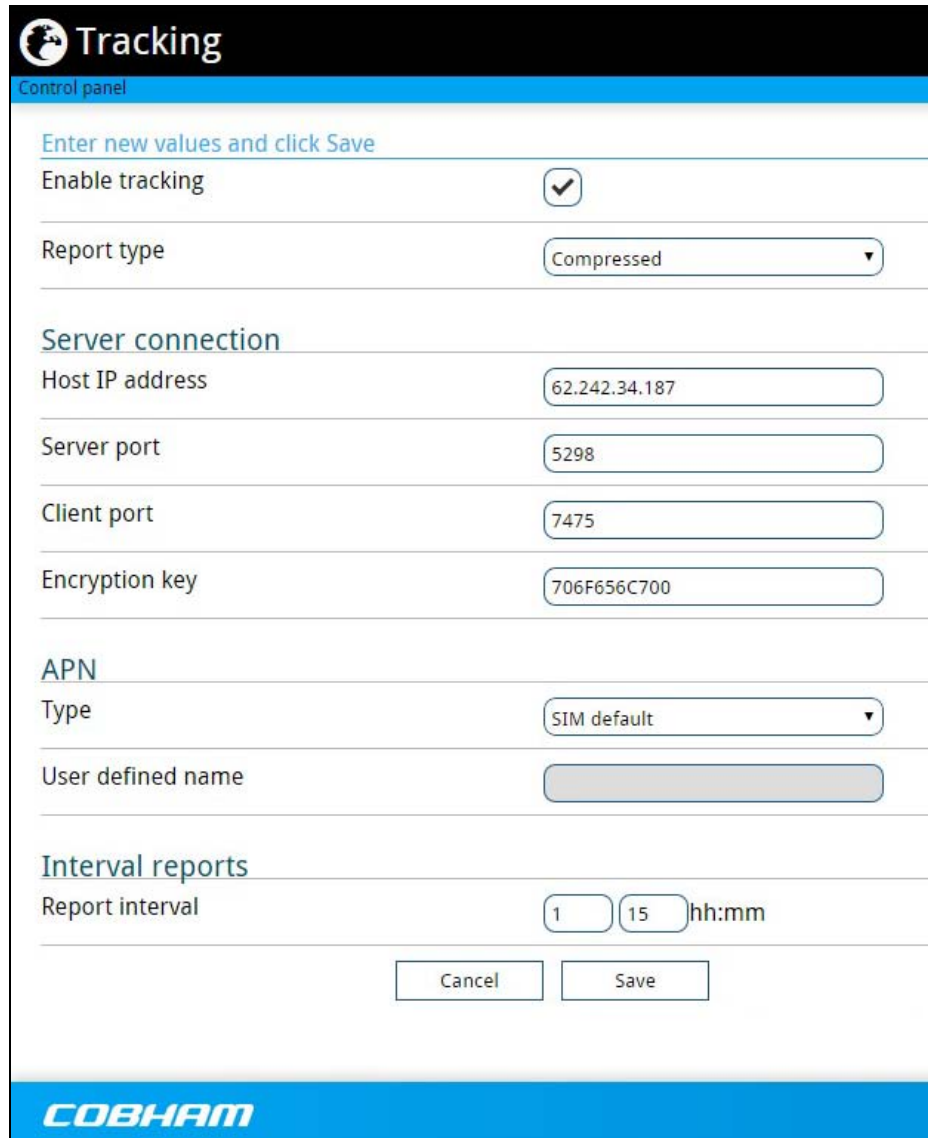

Tracking

Control panel

Enter new values and click Save

Enable tracking

Report type Compressed ▼

Server connection

Host IP address

Server port

Client port

Encryption key

APN

Type SIM default ▼

User defined name

Interval reports

Report interval hh:mm

COBHAM

2. To enable tracking of the EXPLORER 710, select **Enable tracking**.
3. At **Tracking and HDR**, select **Share HDR connection** or **Disable HDR connection**. When tracking is enabled, you cannot use a full HDR or BGAN X-Stream connection, so you must select one of these two options:
 - **Share HDR connection:** When Tracking is enabled and a HDR connection is started, the terminal will use part of the HDR bandwidth for tracking.
 - **Disable HDR connection:** As long as Tracking is enabled, you cannot start a HDR connection.
4. Select the **Report type**.

- **Compressed.** Only latitude and longitude are reported.
 - **Extended.** Apart from latitude and longitude, heading and altitude are also included.
 - **ECEF.** The same information as Extended, but position and speed data are 3D (ECEF coordinates).
5. Under **Server connection**, type in the following details:
 - **Host:** The IP address of the server that the EXPLORER 710 will report to.
 - **Server port:** Port number on the server. Default number is 7474.
 - **Client port:** Port number on the EXPLORER 710. Default number is 7475.
 - **Encryption key:** A supplied 128 bit key which must match on both the client and server side.
 6. Under **APN**, select the source of the APN.
 - **SIM default** (recommended): The APN is taken from the SIM card.
 - **Network assigned:** The APN is assigned from the network.
 - **User defined:** APNs are provided from the Airtime Provider. Type in the APN next to **User defined name**.
 7. Type in the **Report interval** in hours (h) and minutes (m).

Example: If you type in 1 h 30 m, the EXPLORER 710 will send a report for every 1½ hour.
 8. Click **Save**.

If you have disabled HDR in step 3., you can see the status of the tracking link in the status area of the web interface. If the status area is not shown, click  to see it.

Note

You can set up whether or not you want to allow the tracking server to control these settings. See [Remote control of tracking](#) on page 89.

Advanced settings

First time use

The first time you access the EXPLORER 710 web interface the administrator password is disabled, so you have access to all settings. If you want to use an administrator password, you can enable it as described in the next section.

Administrator password

To enable the administrator password

If the administrator password is disabled and you want to protect the advanced settings with a password, do as follows:

1. From the Control panel , select **Advanced**.
2. Select **Enable admin password**.
3. Type in the administrator password you want to use.
4. Repeat the new password on the next line.
5. Click **Save**.

To disable the administrator password

If you want to disable the administrator password, do as follows:

1. From the Control panel , select **Advanced**.
2. If you are not already logged in, enter the administrator password and click **Login**.
3. Select **Disable admin password**.
All settings are now available without password protection.

To log in

If the administrator password is enabled, the Advanced settings require an administrator password. To log in as administrator, do as follows:

1. From the Control panel , select **Advanced**.
If you are not logged in as administrator you are now prompted to log in.
2. Enter the Administrator password.
If you have forgotten the administrator password, you can reset the password. For details, see [To reset the administrator password](#) on page 64. The old user name and password will apply until you have finished the reset procedure.
3. Click **Login**.

To change the administrator password

To change the administrator password, do as follows:

1. Log in as administrator
2. Under **Advanced**, select **Change admin password**.
3. Type in the **Old password**.
4. Type in the **New password** and retype it on the next line.
5. Click **Save**.
At the next login the new password is required.

To log out as administrator

If you have not entered anything for 30 minutes under Advanced, you are logged out automatically. To log out manually, click **Logout admin** in the **Advanced** page.

To set up user permissions

You can allow or deny users access to certain functions and make these pages read-only. This is useful if you want to protect the system against unintended changes. Study this screen thoroughly and decide to which areas of the system you want to give non-administrator users access. To set up the user permissions, do as follows:

1. Under **Advanced**, select **User permissions**.
2. Under **Allow users to:**, select the settings you want to **allow** users to access.
3. Under **Allow AT commands on:**, select **LAN/WLAN interface** if you want to allow the use of AT commands.
AT commands are low-level commands used to control modems, in this case the EXPLORER 710. They are typically used during service and maintenance or when troubleshooting the terminal.
4. Under **Allow user accounts:**, select **Service user account** if you want to enable the use of a service user account.
5. Click **Save**.

The settings without a check mark can only be viewed but not changed by the non-administrator user.

To restore factory settings

To restore the factory settings of the EXPLORER 710, do as follows:

1. Under **Advanced**, select **Factory reset**.

Important

All configuration will be lost and the EXPLORER 710 will return to the default configuration.

2. Click **OK**.
The terminal will now restart and start up with the factory settings.

SIM PIN for BGAN

To enable or disable the use of a SIM PIN

To enable or disable the use of a PIN to access the BGAN network, do as follows:

1. Under **Advanced**, select **SIM**.
2. Select **Enable/disable SIM PIN**.
3. Under **Enable/Disable PIN** select or clear the box next to **Require PIN on startup**.
 - If you clear the box, you can access and use the terminal without entering a PIN
 - If you select the box, you must enter a PIN on startup before you can make calls or data sessions
4. If you selected **Require PIN on startup**, type in the PIN next to **Enter current PIN**.
5. Click **Save**.
The new PIN settings will take effect at next power on.

To change the SIM PIN

To change the PIN used to access the BGAN network, do as follows:

1. Under **Advanced**, select **SIM**.
2. Select **Change SIM PIN**.
3. Under **Change PIN** type in the **Current PIN**.
4. Type in the **New PIN** and retype it on the next line.
5. Click **Save**. The new PIN settings will take effect at next power on.

SIM lock

The SIM lock feature can be used by suppliers to lock your SIM card to a specific provider or distribution partner. For further information, contact your supplier.

SIM PIN for cellular network

Note

The SIM settings for cellular network are only available when the EXPLORER Cellular Modem is inserted.

To enable or disable the use of a SIM PIN

To enable or disable the use of a PIN to access the cellular network, do as follows:

1. Under **Advanced**, select **EXPLORER Cellular Modem**.
2. Select **Enable/disable SIM PIN**.
3. Under **Enable/Disable PIN** select or clear the box next to **Require PIN on startup**.
 - If you clear the box, you can access and use the terminal without entering a PIN
 - If you select the box, you must enter a PIN on startup before you can make calls or data sessions
4. If you selected Require PIN on startup, type in the PIN next to **Enter current PIN**.
5. Click **Save**.
The new PIN settings will take effect at next power on.

To change the SIM PIN

To change the PIN used to access the cellular network, do as follows:

1. Under **Advanced**, select **EXPLORER Cellular Modem**.
2. Select **Change SIM PIN**.
3. Under **Change PIN** type in the **Current PIN**.
4. Type in the **New PIN** and retype it on the next line.
5. Click **Save**. The new PIN settings will take effect at next power on.

To save or load a configuration

If you need to reuse a configuration in another terminal of the same type and software version, you can save your current configuration to a file, which can then be loaded into the other terminal.

Note

Configuration files can only be exchanged between terminals with the same software version!

To save a configuration to a file

To save the current configuration of your EXPLORER 710 to a file on your computer, do as follows:

6. In the **Advanced** page, click **Load/save configuration**.
7. Click **Save configuration**.
The configuration file is saved in the EXPLORER 710.
8. Click **Download configuration...**
The configuration is downloaded from the EXPLORER 710 to the downloads section of your computer.

To load a configuration from a file

To load a configuration from a file into your EXPLORER 710, do as follows:

1. In the **Advanced** page, click **Load/save configuration**.
2. Click **Load configuration**.
3. Browse to the configuration file and click **Open...**

The configuration is now loaded into your EXPLORER 710. When the configuration is loaded successfully, the EXPLORER 710 restarts with the new configuration.

Link monitoring

You can monitor the external IP connection of the EXPLORER 710 system using the link monitoring feature. With this feature activated, the terminal will send out ping commands (ICMP Echo Requests) to a server of your choice.

Note | The data connection must be activated before link monitoring can start. See [To start and stop data connections](#) on page 49.

To set up link monitoring, do as follows:

1. Under **Advanced**, select **Link monitoring**.
2. Select **Enable Link monitoring**.
3. At **Ping interval (minutes)** select the Interval in minutes between the ping commands.
4. Select the **Number of retries** before the terminal restarts.
5. Type in the Primary and optionally the Secondary IP address.
This is the IP address of the server(s) to which the terminal will send ping commands.

Note | Use a server that is reliable and that responds to ICMP Echo Requests.

6. Click **Save**.

When a data session is started, the terminal will start sending ping commands to the Primary IP address the number of times specified at Number of retries. If no response is received, it will send the same number of ping commands to the Secondary IP address, if available. If no response is received here, the terminal will restart.

Data limits

You can set a limit for the use of data services with the EXPLORER 710 system.

If you have entered the call charges in the menu **Call charges**, the system automatically calculates and displays the maximum charges for your data sessions.

Note Thrane & Thrane A/S does not take responsibility for the correctness of the estimated charges. This calculation is only a rough estimate of the charge, based on the tariff entered by the user. Also, the airtime provider may have different methods of calculating the charge.

Once the entered limit is reached, the connection is automatically stopped. This is recorded in the data log. To continue using the data service you must start a new connection by clicking on the desired connection on the startup page.

Note If you have enabled automatic activation of the Standard data connection and you set a data limit for the Standard data connection, automatic activation is disabled.

To set data limits, do as follows:

1. Under **Advanced**, select **Data limits**.
2. Select the type of connection you want to limit.
3. Type in the amount of data or time allowed and select the appropriate units.
4. Select **Enable**.
5. Click **Save** to save the settings.

Call charges

Note Thrane & Thrane A/S does not take responsibility for the correctness of the estimated charges. This calculation is only a rough estimate of the charge, based on the tariff entered by the user. Also, the Airtime Provider may have different methods of measuring the airtime used.

If you know the tariff for your subscribed services, you can enter these tariffs in the web interface and automatically calculate the estimated charges for your calls and data sessions. To enter the call tariffs, do as follows:

1. Under **Advanced**, select **Call Charges**.
2. Select the currency from the **Displayed currency** drop-down list.
3. Enter the tariff for each of the services.
4. Click **Save**.

The entered tariffs are used for estimating the charges for calls and data sessions. For further information, see [Call log](#) on page 52.

To clear the logs

To clear the logs of the terminal, do as follows:

1. Under **Advanced**, click **Clear logs**.
2. Click **OK**.
This will clear the call log and the data log.

To reset the total counters

To reset the counters for the time connected, do as follows:

1. Under **Advanced**, click **Reset total counters**.
2. Click **OK**. This will reset the counters under **Control panel > Logs > Total counters**.

Remote management

You can set up the terminal so that it can be controlled from a remote location.

To set up the terminal for remote management, select **Advanced** > **Remote management** from the **Control panel**.

The screenshot shows the 'Remote management' settings page. At the top, there is a header with a checkmark icon and the text 'Remote management', and a breadcrumb trail 'Control panel > Advanced'. Below the header, a blue bar contains the text 'Enter new values and click Save'. The main content is divided into two sections: 'Remote access with IP' and 'Remote access with SMS'. Each section contains several settings with checkboxes and text input fields. At the bottom, there are 'Cancel' and 'Save' buttons. The COBHAM logo is visible in the bottom left corner, and a navigation bar with various icons is in the bottom right corner. A zoom level of 100% is indicated at the very bottom right.

Remote management
Control panel > Advanced

Enter new values and click Save

Remote access with IP

Enable access to web server

Incoming port for web server

Enable access to AT commands

Incoming port for AT commands

Trusted IP addresses
Add IP address

Remote access with SMS

Enable remote activation of data sessions

Send SMS confirmation

Enable access to AT commands

Password

Trusted phone numbers
Add phone number

COBHAM

100%

Remote access with IP

1. From the **Remote management** page, select **Enable access to web server** and/or **Enable access to AT commands**.
2. Type in the **Incoming port** numbers to use for the web server and for AT commands. The default port numbers are:
 - web server: 80
 - AT commands: 5454

Note | The port number must be available at your service provider.

3. Under **Trusted IP addresses**, click **Add IP address** and type in the IP address of the device you want to give access to the terminal.
4. To add more IP addresses, click **Add IP address** again.

Note | To be able to access the terminal you must have an active data connection.

After preparing the terminal and activating the connection you can access the terminal from one of the trusted IP addresses, using the incoming port defined in the Incoming port field.

- For information on how to prepare the terminal for remote activation of a data connection, see the next section [Remote access with SMS](#).
- For information on how to access the terminal, see [To access the terminal from a remote location](#) on page 36.

If Static IP is included in your airtime subscription, we recommend using this static public IP address for the terminal in order to provide easy access to the terminal. To use the static IP address, it must be included in your airtime subscription and you must set the APN source to SIM default. For details, see [To change the APN for a connection package](#) on page 72.

Remote access with SMS

Note | The terminal must be logged on to the satellite services to receive and accept an SMS. If the SMS is considered too old or sent before the terminal has been switched on and has logged on, the SMS will be ignored.

1. From the **Remote management** page, select whether you want to **Enable remote activation of data sessions**.
2. Select whether you want an **SMS confirmation** for your data activation SMS.

Important | If you want to receive an SMS with the IP address of the terminal after sending an activation SMS, you must select **Send SMS confirmation**.

3. Select **Enable access to AT commands**, if you want to enable the EXPLORER 710 to receive AT commands via SMS for remote management.

4. Enter the password. It can be up to 32 characters long. The characters 0-9, a-z and A-Z are allowed. **The password is mandatory** and must match the password in the SMS. See [To activate a data connection with an SMS](#) on page 37.
5. Enter at least one trusted mobile number from which the terminal accepts an SMS. If no numbers are entered the feature is disabled automatically. Use the wild card * to accept a range of trusted numbers. Leave out the prefix before the country code (example: for "+45" write only "45")

Mobile number with wild card	Mobile numbers accepted
+453955880*	4539558800 to 4539558809
+45395588*	4539558800 to 4539558899

6. To add more phone numbers, click **Add phone number** again.
7. Click **Save**.

For information on how to send an activation SMS, see [To activate a data connection with an SMS](#) on page 37.

Remote control of tracking

When you are using the tracking function of the EXPLORER 710, you can set up the terminal so that the tracking server can access the EXPLORER 710 e.g. to start or stop tracking or to change reporting intervals.

To allow the tracking server to control the tracking settings, do as follows:

1. Under **Advanced**, select **Tracking settings**.
2. Select **Allow remote control of tracking**.
3. Click **Save**.

The EXPLORER terminal will now accept commands from the specified tracking server, for example to change reporting intervals or start/stop reporting.

To configure data connection types and filters

If the default connection types and filters do not meet your requirements, you can build new templates for the connection types and/or traffic flow filters to match your needs.

Connection templates

To access the connection templates, do as follows:

1. Under **Advanced**, select **Templates**.
2. Select **Connections**.
3. To delete a connection type, click  in the right side of the connection type.

- To add a new connection type, click **Add template** and proceed with the next steps.

- Select an existing **Connection template** as a basis for your new template.
- Type in a suitable **Name** for the connection type.
- Select the **Traffic class**.
 - Standard** is a shared, best-effort connection, used e.g. for email or Internet browsing.
 - Streaming** is an exclusive, high-priority connection with a guaranteed bit rate.
- Select the following bit rates:
 - Max. bit rate upload** is the maximum upload bit rate allowed for this connection type.
 - Max. bit rate download** is the maximum download bit rate allowed for this connection type.
 - Guaranteed bit rate upload** is the guaranteed upload bit rate needed for this connection type.
 - Guaranteed bit rate download** is the guaranteed download bit rate needed for this connection type.
- In the **Transfer delay** field, type in the delay in ms. This is the delay from the time data is received in the terminal until it arrives at the receiving end. You can enter one of the following values:
 - 500 ms (error correction is disabled)
 - 4000 ms (error correction is applied)
 - 0 ms (error correction determined by network)
- Click **Save**.

The new template will now be available for selection when you build your connection packages.

Traffic flow filter templates

The traffic flow filters are used to filter the data traffic, so you can use different connection types for different types of traffic. There are two predefined filters, UDP and TCP.

- **UDP** is used for traffic using UDP protocol (such as video streaming or Voice over IP)
- **TCP** is used for traffic using TCP protocol (such as web browsing).

You can also select **No filter**. This option is only suitable for the last connection you add to a connection package, because the filters are applied in the order they are added to the connection package. See [Multiple data connections](#) on page 73.

If the predefined filters do not meet your requirements, you can create additional filter templates. Do as follows:

1. Under **Advanced**, select **Templates**.
2. Select **Traffic flow filters**.

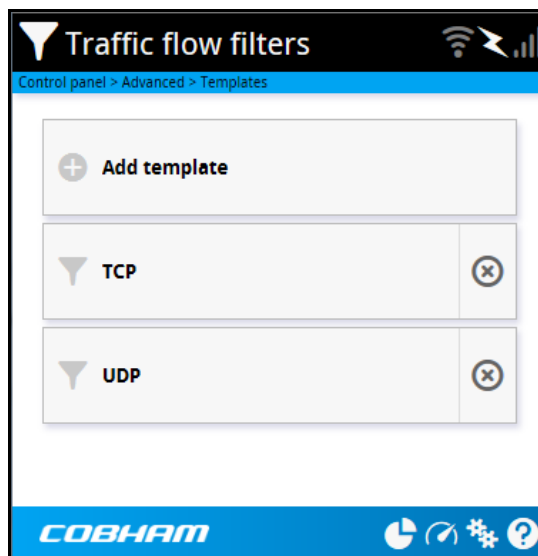

3. To delete a traffic flow filter, click **⊗** in the right side of the filter tile.
4. To add a new traffic flow filter, click **Add template** and proceed with the next steps.

Edit filter

Control panel > Advanced > Templates > Traffic flow filters

Enter new values and click Save

Name

Use global IP filter

Global IP

Subnet mask

Use protocol number filter

Protocol number

Use local port filter

Port start

Port end

Use global port filter

Port start

Port end

Use type of service filter

Type of service

Type of service mask

Use IPsec SPI filter

IPsec Security Parameter Index

COBHAM

5. Type in a suitable name for the filter.
6. Select the item(s) you want to use for filtering and enter the details for the item(s). You can select one or more of the following items:
 - Use global IP filter.
Traffic to and from the IP address or network (subnet mask) entered here is automatically routed to the connection type associated with this traffic flow filter.
 - Use protocol number filter.
This is the type of protocol that is used for the data traffic. E.g. if this is set to 17 (UDP), the filter will automatically route UDP data traffic to the connection type associated with this traffic flow filter.

- Use local port filter.
This is a range of local port numbers on the terminal. The filter will route traffic to and from any of these port numbers to the connection type associated with this traffic flow filter.
- Use global port filter.
This is a range of global port numbers on the terminal. The filter will route traffic to and from any of these port numbers to the connection type associated with this traffic flow filter.
- Use type of service filter.
Type of Service (TOS) is used to define the Quality of Service. Set this value to a number between 0 and 255. The filter will route traffic with this Quality of Service to the connection type associated with this traffic flow filter.
- Use IPsec SPI filter.
IP security. The filter will route traffic using the Security Parameter Index (SPI) stated here to the connection type associated with this traffic flow filter.

7. Click **Save**.

The new filter will now be available for selection when you add new connections to a connection package.

Example: You want a connection package, which allows you to use uninterrupted Voice over IP while having a Standard data connection for web browsing etc.

1. Create a filter template with
 - Protocol=UDP (Use protocol number filter)
 - Type of Service = 0xb8 and Type of Service mask = 255 (Use type of service filter)

The UDP protocol is suitable for UDP voice streaming and the TOS value 0xb8 is used by some linksys Voice over IP adapters.
2. Create a connection package as described in [Multiple data connections](#) on page 73.
3. Add a Standard connection with No filter.
4. Add an additional connection, e.g. 32 kbps Streaming with the new filter you created in step 1.

Help desk

Under Help desk you can enter the contact information you want for your EXPLORER 710. The Help desk contact information is empty by default. You must provide the contact information, e.g. the phone number for your Airtime Provider. Do as follows:

1. In the **Advanced** page, select **Help desk**.
2. Type in the contact information you want.
3. select **Save**.

The Help desk information is now available from the About page ( (Control panel) > **Support > About**).

Optional: To set up cellular network for data

The EXPLORER 710 is a BGAN terminal by default. However, if you are within coverage of a cellular network, you may want to acquire an EXPLORER Cellular Modem as an alternative to the BGAN network. Note that you need a separate SIM card for the cellular network, the EXPLORER 710 SIM card can only be used for the BGAN network.

Note | The EXPLORER 710 does not provide automatic switch-over between BGAN and cellular network, so you have to select the network you want to use.

To enable the EXPLORER 710 to use the cellular network, do as follows:

1. Acquire an EXPLORER Cellular Modem from Cobham SATCOM.
2. Insert your cellular SIM card into the modem and plug the modem into the USB connector on the EXPLORER 710.

Note | The USB interface must be enabled. See [USB interface setup](#) on page 57.

3. Connect your computer, smartphone or tablet to the EXPLORER 710, e.g. using WLAN (see [To connect your WLAN-enabled device](#) on page 8).
4. Start the **EXPLORER Connect** app and select **Terminal Access**, or access the web interface.
5. When the modem is connected, the opening page of the web interface shows a new tile with the cellular connection. The “M” on the tile for the cellular modem indicates that it is a cellular modem and not a BGAN connection.
6. Depending on the configuration you may have to select the cellular network by clicking the tile with the cellular modem and selecting **EXPLORER Cellular Modem**.

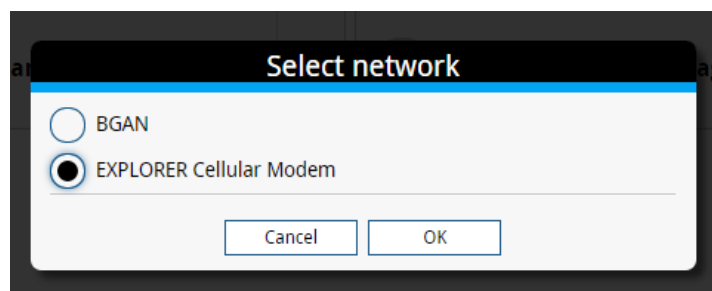

For details on Cellular/BGAN network selection, see [Startup mode \(select network\)](#) on page 66.

7. If required, select  on the tile to set or change the name or the APN of your cellular connection. For details, see the next section.

When the connection is established, an “M” on the signal bar in the top right corner indicates that it is a cellular (Modem) connection, and the tile shows details about the connection.

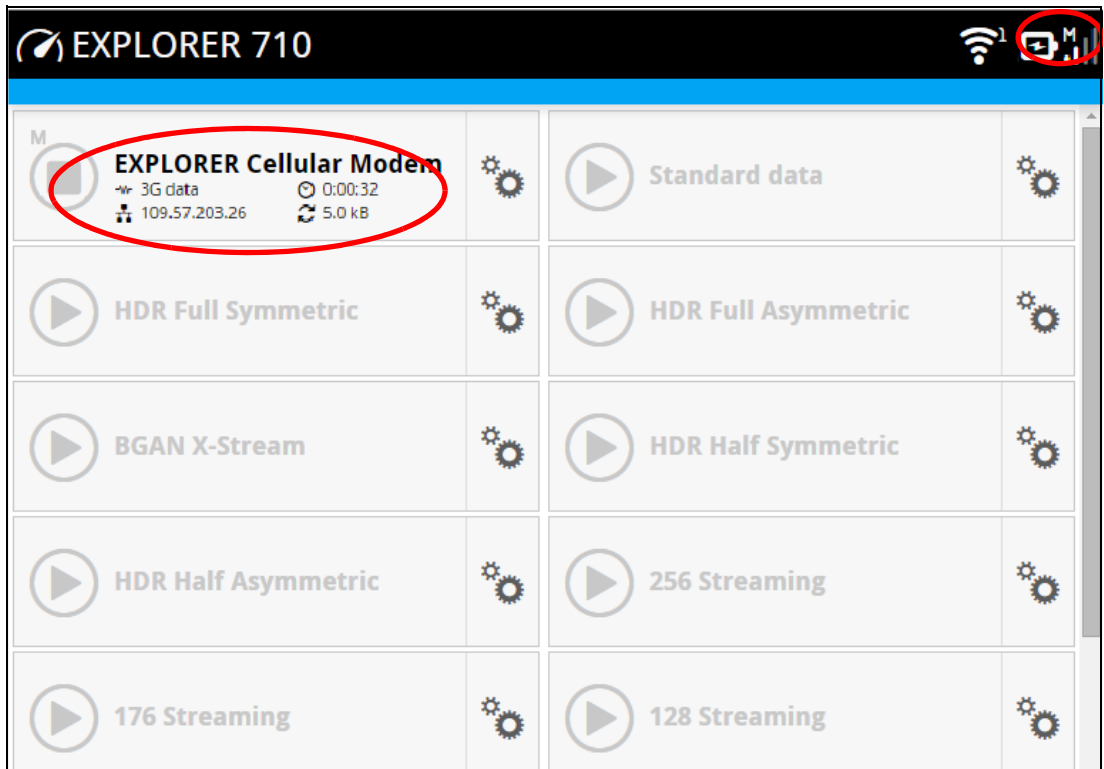

The data connection is automatically established when set up correctly, so you cannot start and stop the cellular connection from the tile as you can with the BGAN connections.

Note You may have to enter a PIN before you can use the cellular network, see [To enter the SIM PIN in the web interface](#) on page 47.

You can now access the Internet through the cellular network from a device connected to the EXPLORER 710. Note that you cannot use the BGAN network as long as EXPLORER Cellular Modem is selected.

Note You cannot make calls on the cellular network through the EXPLORER 710. Only data connection is possible

To change the name or the APN for your cellular connection

Do as follows:

1. Select  on the tile with the cellular connection.
2. Type in the new name for your connection.
3. Type in the name of the APN you are going to use for your cellular connection.
4. Click **Save**.

Maintenance and troubleshooting

To get support

Contact information

Should your Cobham SATCOM product fail, please contact your dealer or installer, or the nearest Cobham SATCOM partner. You will find the partner details on www.cobham.com/communications-and-connectivity/satcom where you also find the Cobham SATCOM Self Service Center web-portal, which may help you solve the problem. Your dealer, installer or Cobham SATCOM partner will assist you whether the need is user training, technical support, arranging on-site repair or sending the product for repair. Your dealer, installer or Cobham SATCOM partner will also take care of any warranty issue.

To repack for shipment

Should you need to send the product for repair, please read the below information before packing the product.

The shipping carton has been carefully designed to protect the EXPLORER 710 and its accessories during shipment. This carton and its associated packing material should be used when repacking for shipment. Attach a tag indicating the type of service required, return address, part number and full serial number. Mark the carton FRAGILE to ensure careful handling.

Note | Correct shipment is the customer's own responsibility.

If the original shipping carton is not available, the following general instructions should be used for repacking with commercially available material.

1. Wrap the defective unit in heavy paper or plastic. Attach a tag indicating the type of service required, return address, part number and full serial number.
2. Use a strong shipping container, e.g. a double walled carton.
3. Protect the front- and rear panel with cardboard and insert a layer of shock-absorbing material between all surfaces of the equipment and the sides of the container.
4. Seal the shipping container securely.
5. Mark the shipping container FRAGILE to ensure careful handling.

Failure to do so may invalidate the warranty.

Software update

Important

If the battery power is 25% or less you must connect DC power to the terminal before starting the software update. Once connected, do not remove DC power until the software update is completed.

To update software using the web interface

See [To update software](#) on page 63.

To update software with USB

If the web interface is not available, you may also use the USB interface to update the software from a USB memory stick.

To prepare the USB stick

Do as follows:

1. Download the EXPLORER 710 software image from the Cobham SATCOM support server¹ to your computer.
2. Insert the USB memory stick into your computer and copy the EXPLORER 710 software image file to the drive.
3. Rename the file name to "tt3720b.tiff".
4. Remove the USB memory stick from the computer.

To upload the software to the EXPLORER 710

1. On the EXPLORER 710, check in the display that the USB interface is enabled.
2. Insert the USB memory stick with the new software into the EXPLORER 710 USB connector on the front.
The EXPLORER 710 reads the software image from the USB memory stick and starts the software update process. The EXPLORER 710 restarts and completes the software update. The Status LED flashes blue to indicate that the software update process is ongoing.
3. Wait for the status LED to become green to indicate the software update process is completed.
4. Remove the USB memory stick.

1. You can download the software from the "Self Service Centre" at www.cobham.com/communications-and-connectivity/satcom, select **Service and Support > AVIATOR, EXPLORER, SAILOR Service and Support** and then **24-7 Self Service Centre / Technical Downloads**. Locate the EXPLORER 710 software.

Recovery software update

If the EXPLORER 710 becomes inoperative, a recovery software update may bring it back into an operational state.

Important | The recovery software update will reset your EXPLORER 710 configuration to factory default!

To make a recovery software update, do as follows:

1. Prepare the USB stick as described in [To prepare the USB stick](#) on page 97.
2. In the display keypad, hold down the "<" and ">" keys while powering on the EXPLORER 710. The EXPLORER 710 powers up and the display shows: SAFE MODE.
3. Insert the USB memory stick with the new software into the EXPLORER 710 USB connector on the front.
The EXPLORER 710 reads the software image from the USB memory stick and starts the software update process. The EXPLORER 710 reboots and when it is powered up the Status LED flashes blue to indicate that the software update process is ongoing.
4. Wait for the status LED to become steady green to indicate the software update process is completed.
5. Remove the USB memory stick.

Maintenance

Normal use of the battery

It is recommended not to partially charge/discharge the battery several times in a row. Partial charging/discharging affects the accuracy of the capacity measurement.

To recharge batteries

One battery inserted

To recharge the battery, connect external power to the DC input of the EXPLORER 710 while the battery is inserted. For details on how to apply external power, see [DC input](#) on page 14.

Two batteries connected

You may connect an extra, external EXPLORER 710 battery for extra capacity. When external power is applied to the EXPLORER 710, both batteries are charged as follows:

One battery is charged to 80%. Then the other battery is charged to 80%, and finally they are both charged the last bit up to 100%. This way both batteries are charged in the shortest possible time.

The display and the web interface of the EXPLORER 710 show battery status such as which battery is currently charging and the battery level.

Deeply discharged batteries (precharge mode)

Never leave the battery fully discharged for a longer period of time. If the battery is not to be used for a shorter period of time (1 month), charge the battery to minimum 20 to 30% and remove it from the EXPLORER 710. If the Battery is stored for more than a month, see [Storage](#) at the end of this section.

If a battery has not been used for a long time and has been discharged below its normal operation range the EXPLORER 710 will not be able to apply the normal battery charging mode. In this case an Alert is generated ("Internal/External battery low voltage") and the EXPLORER 710 will use a precharging mode to recover the battery. The battery status in the local display and the web interface will show "Precharging". No time estimate or battery capacity will be indicated. Depending on how deeply discharged the battery is, the precharging might process for up to 6 hours. After precharging, the EXPLORER 710 will proceed with the normal battery charging.

To connect an extra, external EXPLORER 710 battery

If you are not close to a power source, you may want to use an extra EXPLORER 710 battery as backup. Do as follows:

1. Acquire an extra EXPLORER 710 battery with a dedicated EXPLORER 710 Hot Swap Cable (part number 403720B-010).
2. Connect the dedicated cable between the external EXPLORER 710 battery and the **Ext. Battery** connector on the EXPLORER 710.
The EXPLORER 710 continues normal operation on the inserted battery until it runs out of power.

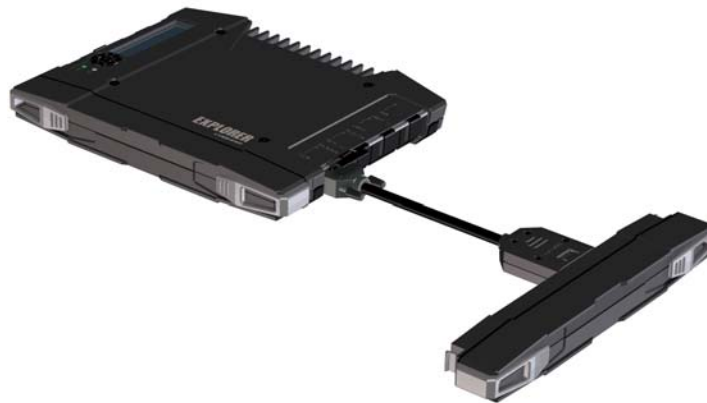

3. When the inserted battery runs out of power, the EXPLORER 710 switches to the external battery and continues normal operation.

Important

Before removing the empty battery, click/select the battery symbol in the web interface or the display and make sure that the EXPLORER 710 is actually running on the external battery.

4. If you have a third charged battery ready, you can now take out the inserted battery and replace it with the new one, without interrupting the operation of the EXPLORER 710.

Accurate display of the battery capacity

To ensure accurate display of the battery capacity, it is recommended to run a “learning cycle” at first time use and then at regular intervals (approximately for every 100 recharge/discharge cycles). The learning cycle must be performed at 20°C-30°C.

A learning cycle is performed as follows:

1. Fully charge the battery.
2. Remove external power and fully discharge the battery:
Use the EXPLORER 710 and/or leave it on until it turns off automatically. This way the EXPLORER 710 “learns” the complete capacity of the battery. Note that it may take several hours to discharge the battery if it is not in use.
3. Recharge the battery.

Storage

Do not leave the battery inserted in the EXPLORER 710 during storage. If the battery is not to be used for a longer period of time, do as follows:

1. Fully charge the battery.
2. Remove external power. Then use the EXPLORER 710 or leave it on until the display shows a battery capacity of approximately 50%.
3. Switch off the EXPLORER 710.

Important | Switch off the EXPLORER 710 before removing the battery!

4. Remove the battery and store it.

In this condition the battery can be stored for approximately 1 year at 20°C to 30°C. After 1 year you must recharge the battery. For further information on storage temperature, see [Battery specifications](#) on page 115.

Disposal of the EXPLORER 710

Old electrical and electronic equipment marked with this symbol can contain substances hazardous to human beings and the environment. Never dispose these items together with unsorted municipal waste (household waste).



In order to protect the environment and ensure the correct recycling of old equipment as well as the re-utilization of individual components, use either public collection or private collection by the local supplier of old electrical and electronic equipment marked with this symbol.

Contact the local supplier for information about what type of return system to use.

Troubleshooting

Troubleshooting guide

Problem	Possible cause	Remedy
The EXPLORER 710 cannot be switched on, or does not stay on when powered by the battery.	The battery needs recharging.	Recharge the battery. Check the battery indicator in the display.
	The battery is not inserted properly.	Remove the battery and re-insert it. Make sure the battery is inserted properly and that the latches are locked.
	The battery contacts are dirty or damaged.	Clean the battery contacts if necessary. If the contacts are damaged, replace the battery.
There is no light in the power indicator nor in the display when the EXPLORER 710 is switched on.	The EXPLORER 710 may be in Stealth Mode (all lights and sounds are off).	Press ◀ and ▶ simultaneously on the display keypad. This will toggle Stealth Mode on/off.
The EXPLORER 710 cannot be switched off.	The Power button was not held long enough.	When you switch off the EXPLORER 710, hold the power button until the light indicator flashes rapidly yellow. In rare cases, it may take up to 10 seconds to switch off the EXPLORER 710.
Charging error	The temperature is outside the limits for charging.	Only charge the battery when the temperature is within the specified range. See Charge temperature on page 115.
	The charging voltage is lower than the specified minimum voltage.	Wait until charging begins (the Status indicator flashes yellow). If the battery is completely discharged, and it has been out of use for a long time, the charging process may take a long time to start. If charging does not begin within 2-3 hours, contact your local supplier, or purchase a new battery.

Problem	Possible cause	Remedy
The EXPLORER 710 is not operational.	Software error	Restart the terminal. If the problem persists, you can make a recovery software upload as described in Recovery software update on page 98. Note: This will reset the configuration of your terminal to factory default!
The display shows Insert SIM.	The SIM card is not present.	Remove the battery and insert the SIM card in the SIM slot according to the instructions in the section To insert the SIM card on page 11.
	The SIM card is not inserted properly.	Remove the SIM card and re-insert it according to the instructions in the section To insert the SIM card on page 11.
The display shows No position fix.	The EXPLORER 710 is unable to register on the network, because the position is unknown.	Make sure the view to the GNSS satellites is not blocked. To obtain position fix, the EXPLORER 710 should be placed flat on an even surface pointing straight upwards, with a clear view to as much of the sky as possible. When the EXPLORER 710 has obtained position fix, you can point the antenna towards the BGAN satellite. To see the position status, select  in the display.
The display shows Emergency calls only.	The BGAN network is only available for emergency calls. The reason may be one of the following: 1) Your Airtime subscription has expired. 2) You are using the wrong SIM card. 3) No SIM card is inserted. 4) You have cancelled the PIN	1) Check your subscription with the Airtime Provider. 2) Check that your SIM card is valid for communication on the BGAN network. 3) Insert the SIM card 4) Enter the PIN

Problem	Possible cause	Remedy
The display shows Not registered.	The EXPLORER 710 cannot register on the BGAN network.	Check that your SIM card is valid for communication on the BGAN network. Check your subscription with the Airtime Provider.
The display shows External control.	The EXPLORER 710 is currently controlled by an external application, e.g. LaunchPad or an AT command interface.	If you want to use the built-in web interface or the display, stop the external application and restart the EXPLORER 710. Then open your browser and access the web interface.
The display shows SIM locked	The SIM card is locked by the supplier e.g. to a specific provider	Contact your supplier
The EXPLORER 710 cannot obtain its position from the GNSS system.	There is no GNSS signal, or the signal is weak. If the EXPLORER 710 has not been used recently within the same location, it can take up to 10 minutes to obtain the position.	Check the GNSS status in the display or the web interface. To help the EXPLORER 710 obtain position fix, it should be placed flat on an even surface pointing straight upwards, with a clear view to as much of the sky as possible. When the EXPLORER 710 has obtained position fix, you can point the antenna towards the BGAN satellite.
No signal or weak signal from the BGAN satellite.	The view to the satellite is blocked.	Make sure the EXPLORER 710 has a clear view to the satellite. Be aware that window glass may reduce the signal level.
	The antenna is pointed in the wrong direction.	Check that the antenna is pointed according to the position data. Adjust the position to the highest possible signal strength.
Connection to the Internet cannot be established.	The signal strength is too low.	Check that the antenna is pointed according to the position data. Adjust the position to the highest signal strength you can obtain. As a rule of thumb, you should have a signal strength of 45 dBHz or more to be able to make a call or data session.

Problem	Possible cause	Remedy
The web interface cannot be accessed.	The browser is configured to use a proxy server.	For Microsoft Internet Explorer, select Tools > Internet Options > Connections > LAN Settings and uncheck Use a proxy server for your LAN .
	You have entered a wrong IP address.	Check the IP address and re-enter it. The default IP address is 192.168.0.1
A Phone connection cannot be established.	The interface is disabled in the EXPLORER 710.	Enable the interface by selecting the Phone interface icon in the display, or by accessing the web interface and selecting Control panel > Phone > Enable .
	The cable is not properly connected.	Connect the cable.
	The cable type or connector type is not correct.	For information on the correct type of connector, refer to Phone interface on page 117.
	Incoming calls: The call type used for the call is not selected in the web interface.	Make sure the call type used for calls to the EXPLORER 710 is selected in the web interface. Access the web interface and select Control panel > Phone . Then select the call type for incoming calls.

Problem	Possible cause	Remedy
An ISDN connection cannot be established.	The ISDN interface is disabled in the EXPLORER 710	Enable the interface by selecting the ISDN interface icon in the display, or by accessing the web interface and selecting Control panel > ISDN > Enable .
	The cable is not properly connected.	Connect the cable.
	You have connected to the LAN interface.	Connect the cable to the interface marked ISDN.
	The cable type or connector type is not correct.	For information on the correct type of connector and cable, refer to ISDN interface on page 118.
	Incoming phone calls: The call type used for the call is not selected in the web interface.	Make sure the call type used for calls to the EXPLORER 710 is selected in the web interface. Access the web interface and select Control panel > ISDN . Then select the call type for incoming calls.
A LAN connection cannot be established.	The interface is off in the EXPLORER 710.	Enable the interface by selecting the LAN interface icon in the display, or by accessing the web interface and selecting Control panel > LAN > Enable .
	The cable is not properly connected.	Connect the cable.
	The cable type or connector type is not correct.	For information on the correct type of connector and cable, refer to LAN interface, 2-port on page 119.
	You have connected to the ISDN interface.	Connect the cable to the interface marked LAN#1 or LAN#2.

Problem	Possible cause	Remedy
A WLAN connection cannot be established.	The WLAN interface is disabled in the EXPLORER 710	Enable the interface by selecting the WLAN interface icon in the display, or by accessing the web interface and selecting Control panel > WLAN > Enable .
	Your computer or smartphone is placed too far away from the EXPLORER 710.	Bring the computer closer to the EXPLORER 710. Note that the specified maximum distance is only valid under ideal conditions.
The USB (Host) interface does not work.	The interface is off in the EXPLORER 710.	Enable the interface by selecting the USB interface icon in the display, or by accessing the web interface and selecting Control panel > USB > Enable .

Status signalling

Means of signalling

The EXPLORER 710 system provides two methods for signalling the status of the system.

- **Status indicator** next to the display keypad
- **Messages** shown in the display and in the web interface.

Status indicator

The EXPLORER 710 has one light indicator showing status.



Indicator pattern		Meaning
●	Green flashing rapidly	Starting up
●	Green flashing slowly	Power on (ready)
●	Green constant	Power on with DC input
●	Yellow flashing slowly	Battery charging
●	Yellow flashing rapidly	Closing down
●	Yellow constant	Warning (user recoverable)
●	Red constant	Error. See the display or the web interface.
●	Blue flashing	Uploading software to the terminal
○	Off	Power off or Stealth mode

Event messages and status messages

In the display of the EXPLORER 710 you can see status messages and alerts that are currently active.

When an alert is active, the display shows a warning symbol . Select it to see a list of currently active alerts.

List of messages

The following list explains some of the messages that may show in the display and in the web interface of the EXPLORER 710.

Displayed text	Explanation	Remedy
POE disabled due to high temperature	The temperature in the terminal is too high. PoE is disabled to reduce the temperature.	Move the terminal to a cooler location, or avoid using PoE.
No antenna. Check antenna cable.	The terminal cannot communicate with the antenna	<ol style="list-style-type: none"> 1. Check antenna cable between terminal and antenna. 2. Reboot the terminal.
Excessive writes to the flash memory	Wrong APN name or user name/ password for a connection which is set to auto-activate	Check that the APN name, user name and password are set up correctly for your connections.
Standard data speed limited due to high temperature	The bit rate of the data channel is reduced because the temperature is too high	Move the terminal to a cooler location
Battery level low	The battery level is low	Charge the battery. See To recharge batteries on page 99.
Temperature too low for charging	The temperature is lower than the minimum charge temperature	Only charge the battery when the temperature is within the specified range. See Charge temperature on page 115.
Temperature too high for charging	The temperature is higher than the maximum charge temperature	Only charge the battery when the temperature is within the specified range. See Charge temperature on page 115.
Antenna - Startup temperature too low	The temperature in the antenna is too low for the system to start up	None. If the ambient temperature is outside the specified limits, the antenna may not be able to start up properly. Refer to General specifications on page 114 for temperature specifications.

Displayed text	Explanation	Remedy
Connection closed. Data or time limit exceeded.	The data connection is closed because a data limit defined in the web interface is exceeded. The data limit may be set to avoid unintentional use of bandwidth, e.g. if you forget to close a connection after use.	Restart the connection e.g. from the display. See To start or stop a data connection on page 32. You can change the data limits in the web interface under Advanced > Data limits.
Automatic activation failed. Reconnecting...	The terminal failed to automatically activate a Standard data connection at start-up, even though it was configured to do so.	Wait for the terminal to reconnect.
Connection failed.	The terminal failed to establish a connection.	Restart the connection e.g. from the display. See To start or stop a data connection on page 32. See the Data log for information on the error.
Connection lost.	The data connection was lost.	Restart the connection e.g. from the display. See To start or stop a data connection on page 32. See the Data log for information on the error.
Network failure.	There is a problem, with the network, e.g. congestion.	Try again later. See the Data log for information on the error. If the problem persists, contact your airtime provider.
Network failure. Reconnecting...	There is a problem, with the network, e.g. congestion. The terminal tries to reconnect because it is set up for automatic activation.	Wait for the terminal to reconnect. See the Data log for information on the error. If the problem persists, contact your airtime provider.

Displayed text	Explanation	Remedy
Unknown connection problem.	There is an unknown problem with the connection.	Restart the connection e.g. from the display. See To start or stop a data connection on page 32. See the Data log for information on the error. If the problem persists, contact your airtime provider.
Not registered to the network	The terminal is not registered on the satellite network.	You can only make a connection if the terminal is registered on the satellite network. Make sure that: <ul style="list-style-type: none"> • The SIM card is present. • The PIN has been entered (if used). • The terminal is pointed. See To get started on page 8 for details.
USB power limited to 0.5A due to high temperature	Because the temperature is too high, the USB power is limited to 0.5 A, even if it is set up to use 1.0 A.	Move the terminal to a cooler location, or avoid connecting equipment that requires more than 0.5 A.
Temperature too low (critical)	Low ambient temperature is causing the performance of the terminal to be degraded or halted.	Move the terminal to a warmer location. For information on ambient temperature limits, see General specifications on page 114.
Too low temperature warning	Low ambient temperature is causing the performance of the terminal to be degraded or halted. The terminal will assume radio silence if the problem is in the ACM module of the antenna.	Move the terminal to a warmer location. For information on ambient temperature limits, see General specifications on page 114.

Displayed text	Explanation	Remedy
Temperature too high (critical)	<p>Terminal: Critically high temperature is causing the terminal to shut down.</p> <p>Antenna: Critically high temperature is causing the antenna to stop transmission.</p>	<p>If possible, move the failing unit to a cooler location. For information on ambient temperature limits, see General specifications on page 114.</p> <p>Contact your supplier if the problem persists.</p>
Too high temperature warning	<p>High ambient temperature is causing the performance of the system to be degraded or halted. If the problem is in the terminal: The bit rate for Standard data is reduced.</p> <p>If the problem is in the antenna: The bit rate is reduced.</p>	<p>Move the terminal to a cooler location. For information on ambient temperature limits, see General specifications on page 114.</p>
Satellite signal lost	The system no longer receives a signal from the satellite.	Make sure the antenna has a clear view to the satellite.
Registration for voice failed	The system has not yet been allowed to register for voice services (Circuit Switched).	If the problem persists, contact your airtime provider.
Registration for data failed	The system has not yet been allowed to register for data services (Packet Switched).	If the problem persists, contact your airtime provider.
Software update still fails after several retries	The terminal was unable to upload new software to the antenna.	Contact your supplier.
Software update failed	The terminal was unable to upload new software to the antenna.	<p>Reboot the terminal.</p> <p>Contact your supplier if the problem persists.</p>
Antenna software could not be loaded	Antenna failed to start up normally.	<p>Reboot the terminal.</p> <p>Contact your supplier if the problem persists.</p>
Antenna could not enter main application mode	Antenna failed to start up normally.	<p>Reboot the terminal.</p> <p>Contact your supplier if the problem persists.</p>

Log files

Diagnostics report

When contacting Cobham SATCOM for support, please include a diagnostic report.

The diagnostic report contains information relevant for the service personnel during troubleshooting.

To generate the diagnostic report, access the web interface and select **Control panel > Support > Diagnostics report**. Then click **Generate report**.

Call log and data log

The log holds detailed information on each call or data session to and from the EXPLORER 710, including date and time, phone numbers, duration, amount of data transferred etc.

Date and time is UTC time, received from the satellite.

For information on how to view the log in the web interface, see [To use the logs](#) on page 52.

Event log

The Event log shows events that occurred in the past and are no longer active. It includes events of informational character describing normal phases of operation for the terminal, and also alerts that have appeared in the Alerts list.

To view the event log in the web interface, select **Event log** from the **Support** page.

Technical specifications

General specifications

Item	Specification
Type	EXPLORER 710, BGAN Class 1 terminal
Max. IP data rate, Rx/Tx ^a Streaming data	492 kbps/492 kbps (simultaneously) 32, 64, 128, 176 and 256 kbps, BGAN X-Stream, HDR Full asymmetric and symmetric, HDR Half asymmetric and symmetric
Physical dimensions	332 x 279 x 54 mm 13.07 x 10.98 x 2.13 inches
Weight	3.5 kg / 7.7 lbs (incl. battery)
Operating temperature Powered by external DC (no battery or fully charged battery) DC operated and charging the battery Powered from battery (discharging) Storage temperature Without battery With battery	-25 to 55°C 0 to 45°C -20 to 55°C -40 to 85°C 1 year at -20 to 25°C 3 months at -20 to 45°C 1 month at -20 to 60°C
Water & Dust Transceiver Antenna	IP52 IP66
Supported web browsers (Others may be supported, these have been tested.)	Safari 5.1.7 and above Internet Explorer 9.0 and above Google Chrome 23 and above Mozilla Firefox 16 and above

a. Performance depends on a wide range of factors and actual usage.

Battery specifications

Item	Specification
Battery type	Lithium Ion
Voltage	10.95 Volt
Capacity	Typ. 5700 mAh
Time between recharging	
Tx time, max	2h30m @ 144 kbps 1h30m @ 492 kbps
Rx time, max	3h30m @ 492 kbps
Charge time	2h. 30 min. charge time
Charge temperature	0 to 45°C (in Japan: 10 to 45°C)
Min. charge cycles	300 (typically up to 500)
Storage temperature	
1 Month	-20 to 60°C
3 Months	-20 to 45°C
1 Year	-20 to 25°C

Interfaces specifications

Power input

Connector pin-out

This drawing shows the pin-out for the DC Power connector.

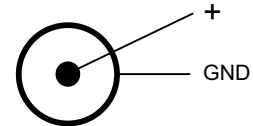

Specifications

Item	Specification
DC input range	+10 to +32 VDC
Power consumption	up to 65 W depending on usage
Connector type	Power Jack - 2,5 mm Center

AC/DC adapter

Item	Specification
AC input range	100 to 240 VAC, 1.5 A, 47 to 63 Hz
DC output	19 VDC, 65 W

External battery connector

The external battery connector is a custom connector strictly for connecting a Cobham SATCOM EXPLORER 710 battery with a dedicated EXPLORER 710 Hot Swap Cable (part number 403720B-010).

Phone interface

Connector pin-out

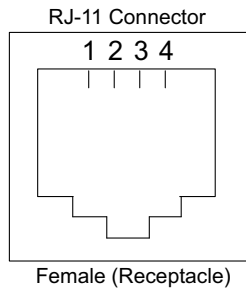

Pin	Function
1	NC
2	Tip
3	Ring
4	NC

Specifications

Item	Specification
Connector type	RJ-11, female
Impedance	180 Ohm + 750 Ohm / 150 nF
Max. cable length	100 m / 80 Ohm

ISDN interface

Connector pin-out

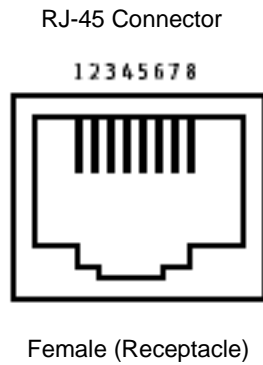

Pin	Function
1	NC
2	NC
3	Rx+
4	Tx+
5	Tx-
6	Rx-
7	NC
8	NC

Specifications

Item	Specification
Connector type	RJ-45, female
Data rate	
Voice	4 kbps
Data	64 kbps
Audio	3.1 kHz
Max. cable length	100 m

LAN interface, 2-port

Connector pin-out

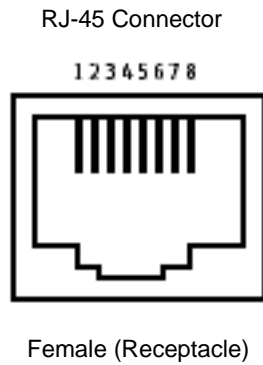

Pin	Function
1	Rx+
2	Rx-
3	Tx+
4	NC
5	NC
6	Tx-
7	NC
8	NC

Specifications

Item	Specification
Number of connectors	2
Connector type	RJ-45, female, Auto cross-over MDI/MDI-X (IEEE 802.3 10/100BaseT)
Standard	ISO/IEC 8877:1992 and IEEE 802.3 1998 Edition
Max. data rate	10/100 Mbps
Max. cable length	100 m / 328 ft with Cat5 UTP

WLAN access point

Specifications

Item	Specification
Standard	IEEE 802.11 b/g
Antenna	External rotatable antenna for increased coverage
Frequencies	2.4 GHz ISM band
Max. coverage outdoor	100 m / 328 ft

USB (Host) interface

Connector pin-out

Pin	Function
1	VBUS
2	D-
3	D+
4	GND

Specifications

Item	Specification
Version	USB v2.0 Host
Connector type	Type A
Charge current available	0.5 A or 2.0 A, user selectable
Max. cable length	5 m / 16.4 ft

Antenna interface on transceiver

Specifications

Item	Specification
Connector type	TNC, female
Max. cable length	Typically up to 100 m depending on the cable type
Max. cable loss	Max 20 dB cable loss at 1.5 to 1.7 GHz Max 3 dB cable loss at 50 to 60 MHz
Max. DC impedance for cables	Max. 1.8 Ohm DC resistance.

Detachable BGAN antenna specifications

Item	Specification
Type	Directional patch array, manually adjustable
Polarization	RHCP, Right-hand circular polarization for both tx and rx
Connector type	TNC
Frequencies	
Inmarsat I-4	
Transmit	1626,5 MHz - 1660,5 MHz
Receive	1525 MHz - 1559 MHz
Inmarsat Alphasat	
Transmit	Extended L-band (XL) ^a : 1626,5 MHz - 1660,5 MHz and 1668 MHz - 1675 MHz
Receive	1518 MHz - 1559 MHz
GNSS	GPS and GLONASS
EIRP	Nominal: 20.0 dBW (EIRP), Class 1

a. Only available within Alphasat coverage. See [Satellite coverage](#) on page 122.

Satellite coverage

The EXPLORER 710 uses the Inmarsat I-4 satellites and the Alphasat satellite for satellite communication. The drawing below shows the coverage areas for these satellites.

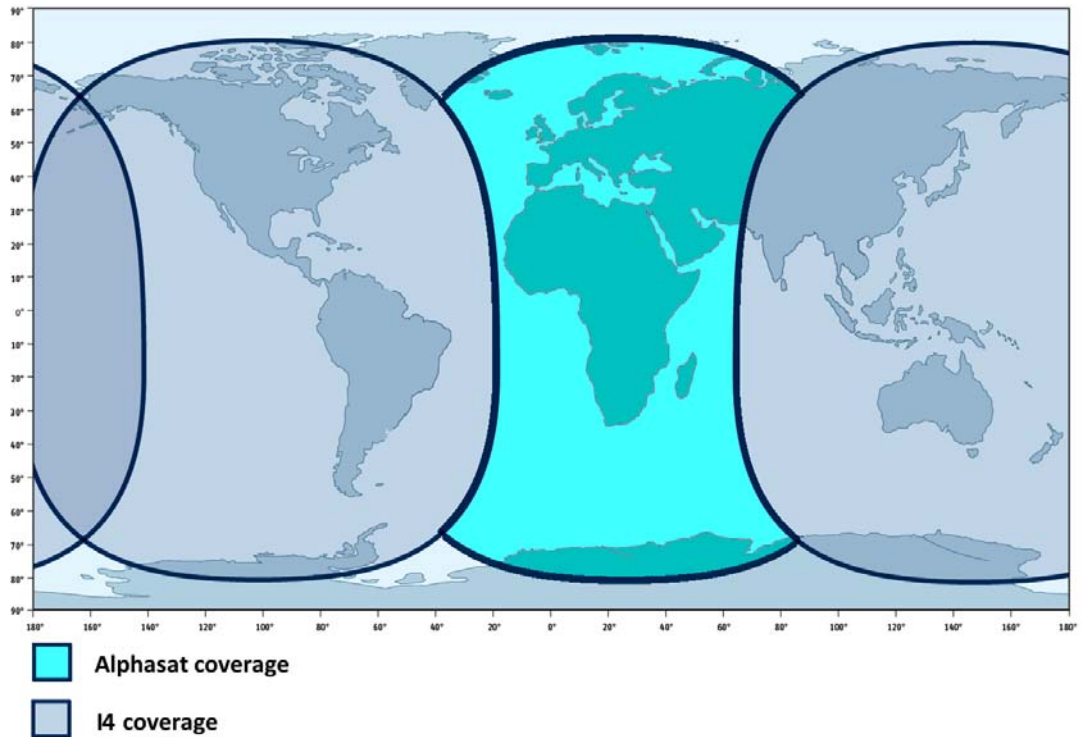

Conformity

General

Approvals for the EXPLORER 710 are listed in the display menu of the EXPLORER 710 terminal. Select  and then **Properties > Conformity**.

CE (R&TTE)

The EXPLORER 710 is CE certified (R&TTE directive) as stated in “Declaration of Conformity with R&TTE Directive”, enclosed in electronic copy on the next page. The WLAN interface is CE certified through the manufacturer of the WLAN card.

Use of WLAN:

The WLAN interface requires that the user enters the current country of operation. See [WLAN interface setup](#) on page 54.

For use in the EU, the following restrictions apply:

- France: Outdoor use must be limited to 10 mW EIRP within the frequency band 2454 MHz to 2483.5 MHz.
- Italy: Outdoor use outside own premises require general authorization.

IC

This device complies with Industry Canada licence-exempt RSS standard(s). Operation is subject to the following two conditions:

- (1) this device may not cause interference, and
- (2) this device must accept any interference, including interference that may cause undesired operation of the device.

Le présent appareil est conforme aux CNR d'Industrie Canada applicables aux appareils radio exempts de licence. L'exploitation est autorisée aux deux conditions suivantes :

- (1) l'appareil ne doit pas produire de brouillage, et
- (2) l'utilisateur de l'appareil doit accepter tout brouillage radioélectrique subi, même si le brouillage est susceptible d'en compromettre le fonctionnement.

This Class [B] digital apparatus complies with Canadian ICES-003.

Cet appareil numérique de la classe [B] est conforme à la norme NMB-003 du Canada.

WLAN:

Under Industry Canada regulations, this radio transmitter may only operate using an antenna of a type and maximum (or lesser) gain approved for the transmitter by Industry Canada. To reduce potential radio interference to other users, the antenna type and its gain should be so

chosen that the equivalent isotropically radiated power (e.i.r.p.) is not more than that necessary for successful communication.

Conformément à la réglementation d'Industrie Canada, le présent émetteur radio peut fonctionner avec une antenne d'un type et d'un gain maximal (ou inférieur) approuvé pour l'émetteur par Industrie Canada. Dans le but de réduire les risques de brouillage radioélectrique à l'intention des autres utilisateurs, il faut choisir le type d'antenne et son gain de sorte que la puissance isotrope rayonnée équivalente (p.i.r.e.) ne dépasse pas l'intensité nécessaire à l'établissement d'une communication satisfaisante.

This radio transmitter (certification number 3913A-APPN551 (Single)) has been approved by Industry Canada to operate with the antenna types listed below with the maximum permissible gain and required antenna impedance for each antenna type indicated. Antenna types not included in this list, having a gain greater than the maximum gain indicated for that type, are strictly prohibited for use with this device.

Le présent émetteur radio (no. de certification 3913A-APPN551 (Single)) a été approuvé par Industrie Canada pour fonctionner avec les types d'antenne énumérés ci-dessous et ayant un gain admissible maximal et l'impédance requise pour chaque type d'antenne. Les types d'antenne non inclus dans cette liste, ou dont le gain est supérieur au gain maximal indiqué, sont strictement interdits pour l'exploitation de l'émetteur.

WLAN antenna types approved for use with the EXPLORER 710:

WLAN antenna for EXPLORER 710, part number 88-139591. Max gain: 1.89 dBi / 50 Ohm.

FCC

Note: This equipment has been tested and found to comply with the limits for a Class B digital device, pursuant to part 15 of the FCC Rules. These limits are designed to provide reasonable protection against harmful interference in a residential installation. This equipment generates, uses and can radiate radio frequency energy and, if not installed and used in accordance with the instructions, may cause harmful interference to radio communications. However, there is no guarantee that interference will not occur in a particular installation. If this equipment does cause harmful interference to radio or television reception, which can be determined by turning the equipment off and on, the user is encouraged to try to correct the interference by one or more of the following measures:

- Reorient or relocate the receiving antenna
- Increase the separation between the equipment and receiver
- Connect the equipment into an outlet on a circuit different from that to which the receiver is connected
- Consult the dealer or an experienced radio/TV technician for help

Part 15.21

Changes or modifications not expressly approved by the party responsible for compliance could void the user's authority to operate the equipment.

Declaration of Conformity with R&TTE Directive

The undersigned of this letter declares that the following equipment complies with the specifications of EC directive 1999/5/EC concerning Radio & Telecommunications Terminal Equipment.

Equipment included in this declaration

TT-3720B	EXPLORER 710 Terminal	PN = 403720B
Consisting of:	TT-3732B EXPLORER 710 Transceiver	PN = 403732B
	TT-3703B EXPLORER 710 Antenna	PN = 403703B

Accessories also included in this declaration

TT-3686G	EXPLORER 710 Battery	PN = 403686G
TT-3682P	AC/DC Adapter	PN = 403682P (FSP065-RAC)

Equipment Applicability

The TT-3720B EXPLORER 710 is a mobile terminal that provides voice, fax or high-speed data communication through the Inmarsat satellite service. The use of WLAN is controlled by a country code loaded in the terminal. The Inmarsat interface to a satellite has no restriction in use. See the User manual for further information.

Declaration

The safety requirement with respect to the LVD directive 73/23/EC is met by conforming to the harmonized EU standard EN 60950. The protection requirement with respect to the EMC directive 89/336/EC is met by conforming to the harmonized EU standards ETSI EN 301489-1, ETSI EN 301489-17 and ETSI EN 301489-20. Effective use of frequency spectrum is met by conforming to the harmonized EU standards ETSI EN 301444 and ETSI EN 300328.

Manufacturer

Thrane & Thrane A/S, Lundtoftegårdsvej 93D, DK-2800 Kgs. Lyngby, Denmark
Industrivej 30, 9490 Pandrup, Denmark

Place and Date

Kgs. Lyngby, 26. June 2014

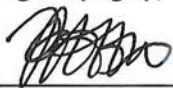

Paul Jona, CEO
Thrane & Thrane A/S

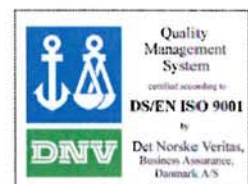

A

APN Access Point Name. The Access Point Name is used by the terminal operator to establish the connection to the required destination network.

B

BGAN Broadband Global Area Network. A satellite network based on geostationary satellites, delivering broadband data and telephony to virtually any part of the earth, with full UMTS (3G) compatibility. BGAN enables users to access e-mail, corporate networks and the Internet, transfer files and make telephone calls.

D

DHCP Dynamic Host Configuration Protocol. A protocol for assigning dynamic IP addresses to devices on a network. With dynamic addressing, a device can have a different IP address every time it connects to the network.

F

FCC Federal Communications Commission. An independent agency of the United States government. The FCC works towards six goals in the areas of broadband, competition, the spectrum, the media, public safety and homeland security.

G

GMPCS Global Mobile Personal Communications Services

GNSS Global Navigation Satellite System. A navigation satellite system using the GPS, GLONASS, Galileo or Beidou system.

H

HDR High Data Rate. A BGAN service supporting a portfolio of four new streaming rates, including asymmetric services.

I

- IC** Industry Canada (French: Industrie Canada) is the department of the Government of Canada with a mandate of fostering a growing, competitive, knowledge-based Canadian economy.
- ICMP** Internet Control Message Protocol. An Internet protocol mostly used for diagnostics.
- IMEI** International Mobile Equipment Identity. A unique number identifying your terminal.
- IMSI** International Mobile Subscriber Identity. A number used to identify the user of a cellular network. It is a unique identification associated with all cellular networks.
- IMSO** International Maritime Satellite Organisation. An intergovernmental body established to ensure that Inmarsat continues to meet its public service obligations, including obligations relating to the GMDSS.
- IP** Ingress Protection. An international classification system for the sealing effectiveness of enclosures of electrical equipment against the intrusion into the equipment of foreign bodies (i.e. tools, dust, fingers) and moisture. This classification system uses the letters "IP"
- IP** Internet Protocol. The method or protocol by which data is sent from one computer to another on the Internet.
- IPsec** Internet Protocol Security. A protocol suite for securing Internet Protocol (IP) communications by authenticating and encrypting each IP packet of a communication session.
- ISDN** Integrated Services Digital Network. A circuit-switched telephone network system, designed to allow digital transmission of voice and data over ordinary telephone copper wires, resulting in higher quality and speed than are available with analog.

L

- LAN** Local Area Network. A computer network covering a small physical area, like a home, office, school or airport. The defining characteristics of LANs, in contrast to wide-area networks (WANs), include their usually higher data-transfer rates, smaller geographic area, and lack of a need for leased telecommunication lines.

M

- MTU** In computer networking, the maximum transmission unit (MTU) of a communications protocol of a layer is the size (in Bytes) of the largest protocol data unit that the layer can pass onwards.

N

NAT Network Address Translation. An Internet standard that enables a local-area network to use one set of IP addresses for internal traffic and a second set of addresses for external traffic. A NAT module makes all necessary address translations.

P

PBX Private Branch Exchange, telephone exchange that serves a particular business or office.

PIN Personal Identification Number. A code number used to provide access to a system that has restricted access.

PoE Power over Ethernet. A standard for combining power supply with transmission of data over the Ethernet. The source unit "injects" power into the Ethernet cable and the power is "picked up" at the connected device.

PPPoE Point-to-Point Protocol over Ethernet. A network protocol for encapsulating Point-to-Point Protocol (PPP) frames inside Ethernet frames. By using PPPoE, users can virtually "dial" from one machine to another over an Ethernet network, establish a point to point connection between them and then securely transport data packets over the connection.

R

RF Radio Frequency. Electromagnetic wave frequencies between 3 kHz and 300 GHz including the frequencies used for communications signals (radio, television, cell-phone and satellite transmissions) or radar signals.

S

SIM Subscriber Identity Module. The SIM provides secure storing of the key identifying a mobile phone service subscriber but also subscription information, preferences and storage of text messages.

SIP Session Initiation Protocol. An application-layer control (signaling) protocol for creating, modifying, and terminating sessions with one or more participants. Used e.g. for Internet telephony.

SPI Security Parameter Index. An identification tag added to the header while using IPsec for tunneling the IP traffic.

U

- UDP** User Datagram Protocol. Part of the TCP/IP suite of protocols used for data transferring. UDP is known as a "stateless" protocol, meaning it doesn't acknowledge that the packets being sent have been received. For this reason, the UDP protocol is typically used for streaming media. While you might see skips in video or hear some fuzz in audio clips, UDP transmission prevents the playback from stopping completely.
- USB** Universal Serial Bus. A specification to establish communication between devices and a host controller (usually personal computers). USB is intended to replace many varieties of serial and parallel ports. USB can connect computer peripherals such as mice, keyboards, digital cameras, printers, personal media players, flash drives, and external hard drives.
- UTC** Coordinated Universal Time. The International Atomic Time (TAI) with leap seconds added at irregular intervals to compensate for the Earth's slowing rotation. Leap seconds are used to allow UTC to closely track UT1, which is mean solar time at the Royal Observatory, Greenwich.

W

- WLAN** Wireless Local Area Network.

Numerics

- 2-wire
 - connect a phone, 23
 - connector, 117

A

- AC/DC adapter specifications, 116
- access
 - remote, 36
- access to settings
 - limit in web interface, 81
- access using AT commands, 36
- admin password
 - change, 81
 - disable, 80
 - enable, 80
 - log in, 80
 - log out, 81
 - reset, 64
- advanced settings, 80
- alerts
 - view in display, 41
 - view in web interface, 62
- Alphasat
 - frequencies, 121
- analogue phone
 - connect, 23
- antenna
 - connect, 14
 - connector, 121
 - detach, 10
 - fixed, 28
 - point, 16
 - separate from transceiver, 10
 - short description, 7
- APN
 - set up for BGAN, 72
- AT commands
 - access with IP, 36
 - remote access with IP, 37
- audio assisted pointing, 17
- automatic activation, 68
- automatic shut down
 - connection, 85

B

- backup configuration, 83
- bandwidth
 - extend by bonding, 32, 69
- battery
 - capacity display accuracy, 100
 - charge, 99
 - discharged, 99
 - hot-swap, 100
 - insert, 11
 - precharge, 99
 - remove, 12
 - safety, iv
 - short description, 7
- BGAN network
 - startup mode, 66
- bonding, 32
 - set up terminals, 69
- brightness in display, 41

C

- call charges
 - estimating in web interface, 85
- call log, 52
- calls
 - make, 38
 - missed, received, outgoing, 52
 - total usage, 53
- CE compliance, 123
- cellular network
 - overview, 16
 - set up, 94
 - startup mode, 66
- channel bonding, 32
 - set up terminals, 69
- charge
 - EXPLORER 710 batteries, 99
 - smartphone or tablet, 40
- charges for calls
 - estimating, 85
- clear logs, 86

- configuration
 - copy, 83
 - IP handsets and smartphones, 61
 - ISDN, 57
 - LAN, 54
 - phone interface, 56
 - save or load, 83
 - USB, 57
 - WLAN, 54

- conformity, 123

- connect a phone

- Phone interface, 23

- WLAN or LAN, 21

- connect interfaces

- LAN, 20

- WLAN, 19

- connect power, 14

- connected devices

- manage, 58

- connection

- automatic shut down, 85

- connection packages

- multiple connections, 73

- connections

- multiple, 73

- connectors, 13

- antenna, 121

- DC input, 116

- ISDN, 118

- LAN, 119

- Phone, 117

- USB Host, 120

- Control panel, 51

D

- data

- limits, set, 85

- log, 52

- Standard, definition, 32

- start or stop connection, 27, 32

- Streaming definition, 32

- total usage, 53

- data connections

- start and stop in display, 27

- start and stop in web interface, 49

- DC input

- connect, 14

- connector, 116

- default IP address, 44

- delivery contents, 8

- detach the antenna, 10

- devices

- manage, 58

- diagnostics report

- create, 62

- disable interfaces, 30

- discharged battery, 99

- display

- adjusting brightness, 41

- change language, 41

- menu overview, 6

- navigation, 5

- overview, 5

- disposal, 101

E

- enable interfaces, 30

- Ethernet connector, 119

- Event log, 62

- extended L-band

- frequencies, 121

F

- factory settings

- restore, 82

- FCC compliance, 123

- fixed installation, 28

- forward port, 55

- frequencies

- extended L-band, 121

- I-4, 121

G

- GNSS

- select system, 70

- troubleshooting, 104

H

- hot-swap EXPLORER 710 batteries, 100

I

- I-4
 - frequencies, 121
- IAI-2 status, 63
- IC compliance, 123
- IMEI number, 42, 63
- IMSI number, 63
- included items, 8
- indicator, Status LED, 108
- initial inspection, 8
- insert battery, 11
- insert SIM card, 11
- interfaces
 - enable or disable, 30
- internet connection mode
 - setting, 68
- IP address
 - for web interface, 44
 - local, setting up, 68
- IP connection
 - monitoring, 84
- IP handset
 - connect, 21
 - manage in the terminal, 61
 - SIP settings, 22
 - user name and password, 61
- ISDN
 - configure, 57
 - connect phone or modem, 24
 - connector, 118
- items included, 8

L

- LAN
 - automatic activation of, 68
 - configure, 54
 - connect a computer, 20
 - connect an IP handset, 22
 - connectors, 119
- language
 - change in display, 41
 - change in web interface, 70
- latch for transport, 9
- LED on front panel, 108
- light indicator, 108

limit

- allowed kB, 85
 - allowed time, 85
 - data, 85
- limiting user access, 81
- link monitoring, 84
- load configuration, 83
- log
 - of calls, 52
 - of data connections, 52
 - of events, 62
- log in as administrator, 80
- log out as administrator, 81
- logs, clear, 86

M

- MAC address
 - connected devices, 58
- manage connected devices, 58
- maximum for data, 85
- menu in display, 6
- modem mode, 68
- monitoring the external IP connection, 84
- multiple data connections, 73

N

- navigation
 - display, 5
- navigation in web interface, 47
- network
 - cellular or BGAN, 16
 - select startup mode, 66

P

- password
 - change, 81
 - disable, 80
 - enable, 80
 - log in, 80
 - log out, 81
 - reset, 64
 - smartphone or IP handset, 61
- permissions
 - setting for users, 81

phone
 configure, 56
 connect to LAN or WLAN, 21
 connect to Phone interface, 23
 connector, 117
 SIP settings, 22

phone call, 38

PIN
 changing for BGAN, 82
 changing for cellular network, 83
 enabling or disabling for BGAN, 82
 enabling or disabling for cellular network, 83
 enter in display, 15
 enter in web interface, 47

ping command from the terminal, 84

point the antenna, 16

point the antenna again, 18

pointing
 audio assisted, 17

pointing process
 restarting, 18

port forwarding, 55

position
 troubleshooting, 104

power
 connecting, 14

Power connector, 116

power supply
 AC/DC adapter, 116

precharging battery, 99

R

recovery
 software, 98

remote management
 access using AT commands, 37
 access using web interface, 37
 activation with SMS, 37
 preparation, 36
 set up in web interface, 87

remove battery, 12

remove SIM card, 12

repoint the antenna, 18

report
 diagnostics, 62

restore factory settings, 82

rights for users
 in web interface, 81

router mode, 68

S

safety summary, iii

save configuration, 83

separate antenna form transceiver, 10

settings
 in web interface, 51
 limit access, 81
 restore, 82

SIM card
 insert, 11
 remove, 12
 short description, 7

SIM lock, 104

SIP settings, 22

smartphone
 charge via USB, 40
 connect for calls, 21
 manage in the terminal, 61
 SIP settings, 22
 user name and password, 61

SMS
 activate data connection, 37

software
 recovery, 98
 update with USB, 97
 update with web interface, 63
 view current version, 42

sound during pointing, 17

Standard data
 definition, 32

start data connection, 27, 32

Status
 view in web interface, 51

status of satellite connection, 63

storage, 101

Streaming data
 definition, 32

T

tablet
 charge via USB, 40

total usage, 53

tracking the terminal, 42
 setup in web interface, 78

Traffic control, 58

transport latch
 opening, 9

troubleshooting, 102

troubleshooting guide, 102
typography used in this manual, vi

U

update software, 63
 USB, 97
usage
 calls and data, 53
USB
 charge smartphone or tablet, 40
 configure, 57
 connector, 120
 update software, 97
user name
 smartphone or IP handset, 61
user permissions
 setting up in web interface, 81

W

warning messages, 41, 62
warranty, 96
web interface
 accessing, 44
 change language, 70
 definition, 44
 navigating, 47
what's in the delivery, 8
WLAN
 automatic activation of, 68
 configure, 54
 connect to, 19

